

Catálogo de Reposição 2026



Sinalsul 



Empresa certificada
IATF 16949

iluminando o futuro da mobilidade



Somos uma indústria brasileira com **30 anos** de história.

Reconhecida por sua postura inovadora, continuamente vem aliando design e tecnologia ao desenvolvimento de produtos de excelência e alta qualidade.

Especializados em componentes de iluminação, sistemas elétricos e peças plásticas para caminhões, ônibus, reboques, veículos utilitários e máquinas agrícolas, possuímos presença consolidada no Brasil, atuando também na América Latina e no mercado Europeu.

Nossa fábrica está localizada em Caxias do Sul - RS, e contempla todos os processos produtivos dos nossos produtos.

30
ANOS





- 2** Institucional
- 3** Sumário
- 04 - 13** Mercedes-Benz
- 14 - 16** Scania
- 16 - 18** Volvo
- 19 - 29** Ford | Volkswagen | Man | Outros

- 30 - 58** Lanternas e conjuntos traseiros
- 59 - 81** Delimitadoras e laterais
- 82 - 86** Lanternas dianteiras
- 87 - 92** Acessórios
- 93 - 96** Lanternas de placa
- 97 - 100** Retrorrefletores
- 101 - 103** Faróis de trabalho
- 104 - 109** Iluminação interna
- 110 - 114** Sistemas elétricos
- 117 - 127** Índice

LEGENDA



Ônibus



Posição lateral integrada



Resistência IP67



Caminhão



Sistema Flashing



Atende CONTRAN



Implementos



ECE



Produtos originais Sinalsul



Motorhome



R149



Acessórios e Suportes



Resistência IP69K



Agrícola



EMC



Peças de Reposição para Caminhões





Lanterna traseira multifunção Mercedes-Benz



Código	Cód. Original	Fixação	Observação	Conexão
1420 06 20 5E	A0035446803		Com vigia	
1420 06 21 5D	A0035446903	Original	Sem vigia e sem sirene de ré	Original 7 vias
1420 06 20 5D	A0035447003		Com sirene de ré	
3430 06 90 50	A0025447390		Lente D/E	



Lanterna traseira multifunção Mercedes-Benz



Código	Cód. Original	Fixação	Observação	Conexão
1040 CV PS	688 544 71 03	Original	Com vigia	Fios
1040 SV PS	688 544 72 03		Sem vigia	
1080 CV PS	688 544 91 03	Original	Com vigia	Original 5 vias
1080 SV PS	688 544 92 03		Sem vigia	
1090	958 540 02 70	Original	Com vigia	Original Axor 2016+
1091	958 540 01 70		Sem vigia	
040 - Lente D/E BH1X13444AA				



Lanterna traseira multifunção Mercedes-Benz Axor e Actros



Código	Cód. Original	Fixação	Observação	Conexão
1348	A 001 540 6270	Original	Com vigia	Original Axor 2016+
1347	A 001 540 6370		Sem vigia	
348 - Lente E A 002 544 1290				
347 - Lente D A 002 544 1690				





Lanterna traseira Mercedes-Benz sem ré



Código	Cód. Original	Fixação	Observação	Conexão
1513 CV	344 544 70 03	Original	Com vigia	Fios
1513 SV	344 544 71 03		Sem vigia	
513 Lente D/E	008 544 00 90			



Lanterna traseira Mercedes-Benz com ré



Código	Fixação	Observação	Conexão
1514 CV	Original	Com vigia	Fios
1514 SV		Sem vigia	
514 Lente D/E			



Lanterna traseira multifunção Mercedes-Benz lente lisa



Código	Fixação	Observação	Conexão
1077 CV	Original	Com vigia	Fios
1077 SV		Sem vigia	
077 PS Lente D/E			



Lanterna traseira LED multifunção Mercedes-Benz



Chicote 080 disponível para lanterna 2028



Código	Fixação	Tensão	Observação	Conexão
2027 CV	Original	LED BIVOLT	Com vigia	Fios
2027 SV			Sem vigia	
2028 CV	Original	LED BIVOLT	Com vigia	Original 5 vias
2028 SV			Sem vigia	

077 PS Lente D/E



Lanterna direcional dianteira Mercedes-Benz 709, 912, 708, 710 e 712



Sugerimos o uso da porca 032



Código	Cód. Original	Fixação	Cor	Conexão
1371 D AM	688 820 70 21		Amarela	
1371 D CR	-	Original	Cristal	Original
1371 E AM	688 820 71 21		Amarela	
1371 E CR	-		Cristal	



Lanterna direcional dianteira Mercedes-Benz 1618



Sugerimos o uso da porca 032



Código	Cód. Original	Fixação	Cor	Observação	Conexão
1372 D AM	1072D-MBB-384 820 71 21		Amarela	Sem meia-luz	Original
1372 D AM	1072E-MBB-384 820 70 21	Original			
1372 D ML CR	1072DML-MBB-A 694 820 70 21		Cristal	Com meia-luz Possui cúpula	
1372 E ML CR	1072EML-MBB-A 694 820 70 21				



Lanterna direcional dianteira Mercedes-Benz Axor



Código	Cód. Original	Fixação	Conexão
1052 D	940 820 04 21	Original	Original
1052 E	940 820 03 21		



Lanterna direcional dianteira Mercedes-Benz Atego



Código	Cód. Original	Fixação	Conexão
1078 D	973 820 06 21	Original	Original
1078 E	973 820 05 21		



Lanterna direcional dianteira Mercedes-Benz Atego ≥ 2012 e Actros ≥ 2016



Código	Cód. Original	Fixação	Conexão
1360 D	A 958 820 01 21	Original	Original
1360 E	A 958 820 02 21		



DRL Ø83mm

DRL (Daytime Running Light), posição e direcional dianteira LED Mercedes-Benz Accelo



Código	Cód. Original	Fixação	Tensão	Conexão
2999 13 20 4F	A 9798200356	Traseira	LED 24V	4 vias selado

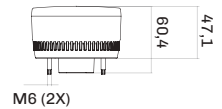
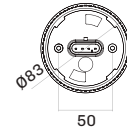

Lanterna direcional lateral para-lama Mercedes-Benz Axor



0410 00 90 60
Chicote com suporte



Código	Cód. Original	Fixação	Conexão
1410 01 90 10	940 820 0221	Original	Original



Lanterna direcional para-lama Mercedes-Benz Atego



Código	Cód. Original	Fixação	Cor	Conexão
1058 D AM	973 820 04 21		Amarela	
1058 D CR	-	Original	Cristal	2 vias Bulldog
1058 E AM	973 820 03 21		Amarela	
1058 E CR	-		Cristal	
058 D/ E AM - Lente			Amarela	
058 D/ E CR - Lente			Cristal	



Lanterna direcional para-lama Mercedes-Benz



Código	Cód. Original	Fixação	Cor	Conexão
1066 AM	331 822 70 20		Amarela	
1066 CR	-		Cristal	Original
1066 1 AM	350 820 70 05		Amarela	
066 AM - Lente	001 822 55 10		Amarela	
066 CR - Lente	-		Cristal	



Lanterna direcional para-lama Mercedes-Benz



Código	Cód. Original	Fixação	Cor	Conexão
1065 AM	331 822 70 20	Original	Amarela	Original
065 AM - Lente	-		Amarela	



Lanterna direcional dianteira Mercedes-Benz 608



Código	Fixação	Cor	Conexão
1106 AM		Amarela	
1106 CR	Original	Cristal	Original
1106 VM		Vermelha	
106 AM - Lente		Amarela	
106 CR - Lente		Cristal	
106 VM - Lente		Vermelha	



Lanterna delimitadora cabine Mercedes-Benz



Código	Cód. Original	Fixação	Conexão
1075	688 820 78 56	Original	Fios



Lanterna delimitadora cabine Mercedes-Benz Accelo, Atego e Axor



Código	Cód. Original	Fixação	Conexão
1057 D	002 820 51 56	Original	Original
1057 E	002 820 50 56	Original	Original



Lanterna delimitadora cabine Mercedes-Benz



Código	Cód. Original	Fixação	Cor	Conexão
1068 AM	331 826 71 47		Amarela	
1068 CR	331 826 73 47	Original	Cristal	Original
1068 VM	331 826 72 47		Vermelha	
068 AM - Lente	331 826 70 10		Amarela	
068 CR - Lente	826 72 10		Cristal	
068 VM - Lente	331 826 71 10		Vermelha	



Lanterna de posição LED com retrorrefletor Mercedes-Benz Atego e Actros



Código	Cód. Original	Fixação	Tensão	Conexão
2014 24 AM	000 544 52 11	Original	LED 24V	2 vias selado JP 2,8



Lanterna de posição Mercedes-Benz 709 e 912



Código	Cód. Original	Fixação	Cor	Conexão
1073 AM	688 820 70 56	Original	Amarela	Original
073 AM - Lente	000 820 00 56		Amarela	



Lanterna de posição para-lama Mercedes-Benz



Código	Cód. Original	Fixação	Observação	Cor	Conexão
1069 AM	-			Amarela	
1069 CR	-			Cristal	
1069 S AM	384 820 70 56	Original	Sem soquete	Amarela	Fios
1069 S CR	-			Cristal	



Lanterna de posição LED para-lama Mercedes-Benz



Código	Fixação	Tensão	Cor	Conexão
2069 AM	Traseira	LED BIVOLT	Amarela	Fios
2069 CR			Cristal	



Retrorefletor Ø60mm Mercedes-Benz



Código	Cód. original	Fixação	Cor
1154 1 25 AM	688 820 78 56	Parafuso M6 x 25mm	Amarela

59,5

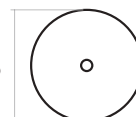

7,8



Lanterna traseira multifunção Scania S4/PGR



- Luz de neblina na posição original;
- Efeito retrorreflexivo conforme resolução 667/17 do Contran;
- Terminais em inox;
- Fixação padrão original.

Código	Cód. Original	Fixação	Observação	Conexão
1345	1756754	Original	Com vigia	Original
1346	1756751		Sem vigia	
345 - Lente D	1784669			
346 - Lente E	1784670			



Lanterna traseira multifunção Scania 113 E 142



Código	Cód. Original	Fixação	Observação	Conexão
1044 SV	527065	Original	Com vigia	Fios
1044 CV	527065		Sem vigia	
044 SV - Lente D	1670289			
044 CV - Lente E	1670292			



Lanterna direcional dianteira Scania Série 4



Código	Cód. Original	Fixação	Conexão
1049 D	1520130	Original	Original
1049 E	1520131	Original	Original



Lanterna direcional dianteira Scania 112 e 113



Código	Cód. Original	Fixação	Conexão
1043 D	394767	Original	Original
1043 E	394766	Original	Original
043 D - Lente	1953508		
043 E - Lente	1953507		



Lanterna direcional lateral LED Scania



Código	Cód. Original	Fixação	Tensão	Conexão
2620 01 20 1D	2334728	Original	LED 24V	Original
2620 01 20 1E	2334727	Original	LED 24V	Original



Lanterna de posição LED com retrorefletor Scania



Código	Cód. Original	Fixação	Tensão	Conexão
2630 07 20 10	2052119	Original	LED 24V	2 vias selado JP 2,8 



Lanterna delimitadora cabine Scania



Código	Cód. Original	Fixação	Conexão
1046 D	301844	Original	Original
1046 E	301843	Original	Original



Lanterna traseira multifunção Volvo



Código	Cód. original	Fixação	Observação	Conexão
1025 CV	20507623	Original	Com vigia	Original 
1025 SV	20507623		Sem vigia	
1026 CV	-	Original	Com vigia	Fios
1026 SV	-		Sem vigia	
250 Lente D/E	20425732			



Código	Cód. Original	Fixação	Tensão	Conexão
1027 24 D	82355678	Original	LED 24V	2 vias selado JP 2,8 
1027 24 E	82114500		LED 24V	



Lanterna direcional lateral Volvo VM



Código	Cód. Original	Fixação	Conexão
1023 AM	21341202	Original	Original



Lanterna direcional dianteira Volvo FH 1998 - 2003



Código	Cód. Original	Fixação	Conexão
1024	1520130 1520131	Original	Original



Lanterna dianteira delimitadora LED Volvo FH4



Código	Cód. Original	Fixação	Tensão	Conexão
2570 04 30 4E	82349220		LED BIVOLT	
2570 04 30 40	82348508		LED BIVOLT	Original
2570 04 30 4D	82349221		LED BIVOLT	



Lanterna delimitadora Volvo FH



Código	Cód. Original	Fixação	Tensão	Conexão
2037 24	82116545	Original	LED 24V	2 vias selado JP 2,8



Lanterna de posição LED com retrorrefletor Volvo FH (2015 em diante)



Código	Cód. Original	Fixação	Tensão	Conexão
2026 24	20789440	Original	LED 24V	2 vias selado JP 2,8



Lanterna traseira multifunção MAN

Disponível
chicote 208

Código	Cód. Original	Fixação	Observação	Conexão
1248	2V5945111	Original	Com vigia	Original
1247	2V5945096C		Sem vigia	
247 - Lente D	2V5941112			
248 - Lente E	2V5945095B			



Lanterna traseira multifunção Ford Cargo ≥ 2011

Chicote 080
disponível para
lanterna 1080

Código	Cód. Original	Fixação	Observação	Conexão
1040 CV	-	Original	Com vigia	Fios
1040 SV	-		Sem vigia	
1080 CV	CC4513405AB	Original	Com vigia	Original 5 vias
1080 SV	CC4513405AB		Sem vigia	



Lanterna traseira Volkswagen e Ford com direcional amarelo



Código	Cód. Original	Fixação	Observação	Conexão
1041 CV	-	Original	Com vigia	Fios
1041 SV	-	Original	Sem vigia	Fios



Lanterna traseira Volkswagen e Ford com direcional cristal



Código	Fixação	Observação	Conexão
1032	Original	Com vigia	Fios
1033	Original	Sem vigia	Fios

031 - Lente



Lanterna traseira Volkswagen ≥ 2012



Código	Cód. Original	Fixação	Observação	Conexão
1086	2S2945096	Traseira (não inclui kit)	Com vigia	Fios
1087	2S2945095	Traseira (não inclui kit)	Sem vigia	Fios

087 - Lente



Lanterna de posição lateral e direcional LED Volkswagen Delivery e Man Meteor



Disponível chicote 303



Código	Cód. Original	Fixação	Tensão	Conexão
2125 AM	12V: 2P0 953 037 24V: 2P2 953 037	Original	LED BIVOLT	3 vias selado 



Lanterna de posição lateral e direcional Volkswagen Constellation



Código	Cód. Original	Fixação	Observação	Cor	Conexão
1310 AM	2R2 953 037	Original	Com vigia	Amarelo	Fios
1310 CR	-	Original	Sem vigia	Cristal	Fios



Lanterna de posição lateral e direcional LED Volkswagen Constellation

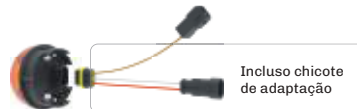

Código	Fixação	Tensão	Conexão
2126 AM	Adaptação para substituir a 1310	LED BIVOLT	2 vias selado 2 vias Bulldog 



Lanterna de posição lateral e direcional LED Volkswagen Delivery 2018



Código	Cód. Original	Fixação	Tensão	Conexão
2590 22 30 10	12V: 23B953037A 24V: 23B953037	Original	LED BIVOLT	3 vias selado 

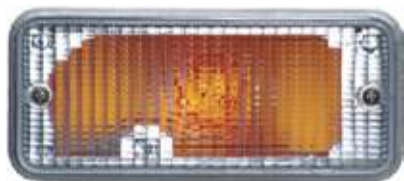

Lanterna direcional dianteira Volkswagen com cúpula



Código	Cód. Original	Fixação	Conexão
1169	TAC 953 041	Original	Original
169 - Lente	2TA 953 161		



Lanterna direcional dianteira Volkswagen



Código	Cód. Original	Fixação	Cor	Conexão
1170 AM	T11 953 041	Original	Amarela	Original
1170 CR	-	Original	Cristal	Original
169 AM - Lente	T12 953 141			
169 CR - Lente	2TA 953 161X			



Lanterna direcional dianteira Volkswagen Constellation



Código	Cód. Original	Fixação	Conexão
1166 D	212 294 102 A	Original	Original
1166 E	212 294 101 A	Original	Original



Lanterna direcional dianteira Ford Cargo ≥ 2011



Código	Cód. Original	Fixação	Conexão
1370	4x2, 6x2: 4C46/13368/BA 6x4: 4C46/13368/CA	Original	Original



Lanterna de posição e direcional Ford Cargo ≥ 2011



Código	Cód. Original	Fixação	Observação	Conexão
1315 AM	Direita: AC46/13B376/AE Esquerda: AC46/13B377/AE	Original	Serve para o lado esquerdo e direito	Original



Lanterna de posição e direcional Ford Cargo C-816 e C-1118



Disponível chicote **037**,
038 e soquete **028**



Código	Cód. Original	Fixação	Observação	Conexão
1195	Direita: EC45/13B376/AD Esquerda: EC45/13B377/AD	Original	Serve para o lado esquerdo e direito	Original



Lanterna direcional dianteira Ford Cargo



Código	Cód. Original	Fixação	Cor	Conexão
1277 AM	90H U13 368 B	Original	Amarelo	Original
1277 CR	-		Cristal	
277 AM - Lente	-		Amarelo	
277 CR - Lente	-		Cristal	



Lanterna direcional dianteira Ford Cargo



Código	Cód. Original	Fixação	Cor	Conexão
1269 D PS AM	86H U13 368 AA	Original	Amarelo	Original
1269 E PS AM	86H U13 368 AA			
1269 D PS CR	2UH 953 042		Cristal	
1269 E PS CR	2UH 953 041			



Lanterna direcional dianteira Ford Cargo com refletor diamantado



Código	Fixação	Cor	Observação	Conexão
1270 D ACR AM	Original	Amarelo	Refletor interno diamantado	Original
1270 E ACR AM				
1270 D ACR CR		Cristal		
1270 E ACR CR				



Lanterna delimitadora LED cabine Volkswagen e Ford



Código	Fixação	Tensão	Observação	Conexão
2063 01 CR			Ford Cargo (centro)	
2063 02 CR	Original	LED BIVOLT	Volkswagen	Fios
2063 D CR			Ford Cargo	
2063 E CR				



Lanterna delimitadora LED cabine Volkswagen e Ford



Código	Fixação	Tensão	Conexão
2062 CR	Original	LED BIVOLT	Fios



Lanterna delimitadora LED cabine Volkswagen e Ford



Código	Cód. Original	Tensão	Observação	Cor	Conexão
1276 E AM	-			Amarela	
1276 D AM	-		Ford Cargo	Amarela	
1276 E CR	-			Cristal	
1276 D CR	-	Original		Cristal	Original
1276 01 AM	-		Volkswagen (centro)	Amarela	
1276 01 CR	-			Cristal	
1276 02 AM	2TA 945 051 B		Volkswagen	Amarela	
1276 02 CR	-			Cristal	



Lanterna delimitadora cabine Volkswagen e Ford



Código	Cód. Original	Fixação	Observação	Cor	Conexão
276 AM	-			Amarela	
276 CR	2R2 945 341 A1	Original	Com soquete		Original
301 CR	-		Sem soquete	Cristal	



Lanterna de posição para-lama Ford



Código	Cód. Original	Fixação	Observação	Cor	Conexão
1069 AM	-			Amarela	
1069 CR	-			Cristal	
1069S AM	384 820 70 56	Original	Sem soquete	Amarela	Fios
1069S CR	-			Cristal	



Lanterna de posição LED para-lama Ford



Código	Fixação	Tensão	Cor	Conexão
2069 AM			Amarela	
2069 CR	Traseira	LED BIVOLT	Cristal	Fios



Lanterna delimitadora cabine Volkswagen



Código	Cód. Original	Fixação	Cor	Conexão
2242 AM	-	Original	Amarelo	Original
2242 CR	2TA 945 051 B		Cristal	
242 AM - Lente	-		Amarelo	
242 CR - Lente	2TA 945 425		Cristal	



Lanterna delimitadora LED Volkswagen Delivery 2018 ≥



Código	Cód. Original	Fixação	Tensão	Conexão
2580 04 30 40	12V: 23B945341E 24V: 23B945341D	Original	LED BIVOLT	2 vias selado 



Lanterna de posição Volkswagen



Código	Cód. Original	Fixação	Cor	Conexão
1137 AM	-	Original	Amarela	Original



Euro 2

DRL (Daytime Running Light) Iveco Tector

Código	Cód. Original	Fixação	Tensão	Conexão
2534 19X 22 4A	5803135639	Frontal	LED 24V	2 vias selado 
2544 19X 22 4B	5803135638			

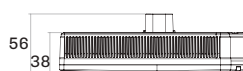

Lanterna direcional para-lama Iveco Tector



Código	Cód. Original	Fixação	Observação	Conexão
1440 01 90 60	5801573146	Original	Suporte de fixação incluso	Lingueta superseal 1,5 
3440 01 90 10	1875578		Lente	



Lanterna traseira multifunção DAF



Código	Cód. Original	Fixação	Observação	Conexão	
1450 06 90 7E	1875577	Original	Com vigia	Original	
1450 06 90 7D	1875578		Sem vigia		
3450 06 90 7E	1914690		Lente E		
3450 06 90 7D	1914691		Lente D		



Lanternas e Conjuntos Traseiros



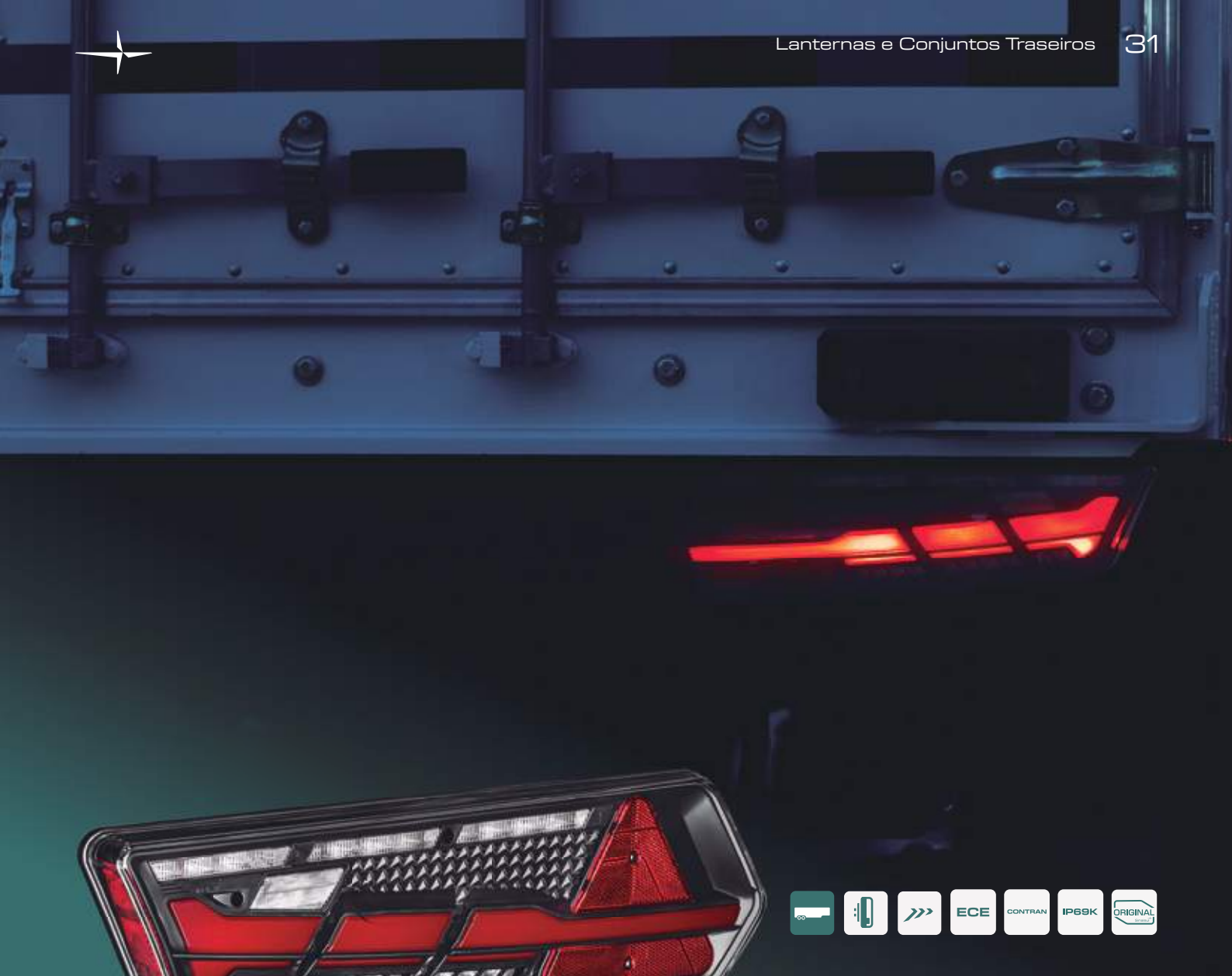

VISION

Lanterna traseira multifunção com auxiliar flashing

Código	Lado	Fixação	Tensão	Observação	Conexão
2842 06 60 5D	Direita	Traseira	LED BIVOLT	Sem auxiliar de posição lateral	5 vias selado + auxiliares
2842 06 60 5E	Esquerda				
2840 06 50 5D	Direita		LED 24V	Posição lateral integrada	
2840 06 50 5E	Esquerda				



Posição lateral integrada (VER. LED 24V)

Posição

Freio

Direcional sequencial segmentado wiping

Ré



FLASHING
Auxiliar de posição com pisca lateral (2 vias)

Auxiliar de ré (2 vias)

Auxiliar de posição (2 vias)

Alimentação multifunção (5 vias)

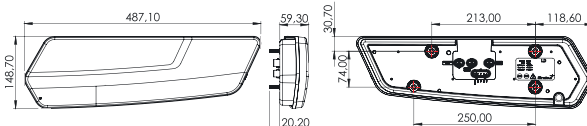

Aplicação: Truckvan

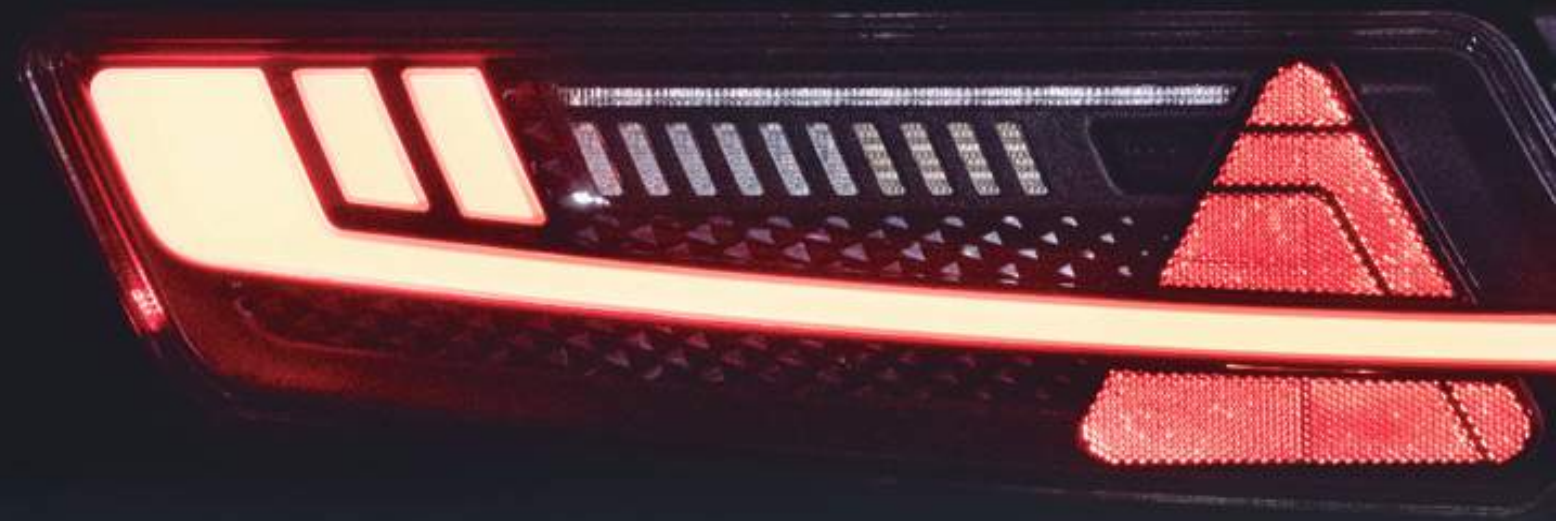

S96

Lanterna traseira multifunção com auxiliar flashing

Código	Lado	Fixação	Tensão	Modelo	Conexão
2780 06 50 5D	Direita	Traseira	LED 24V	S96 - Padrão	5 vias selado + auxiliares
2780 06 50 5E	Esquerda				
2780 06 51 5D	Direita	Traseira	LED 24V	S96 Red	5 vias selado + auxiliares
2780 06 51 5E	Esquerda				
2780 06 50 6D	Direita	Traseira	LED 24V	S96 Silver	5 vias selado + auxiliares
2780 06 50 6E	Esquerda				

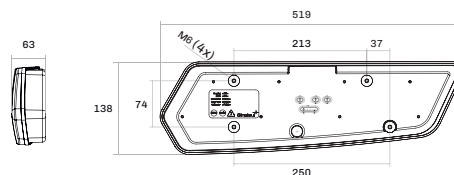



2830 11 2020

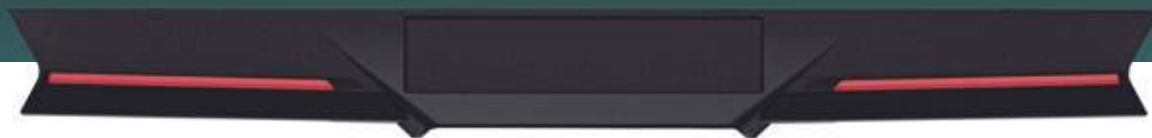

INFINITE

Acabamento traseiro central



2810 11 2020

Código	Fixação	Tensão	Observações	Conexão
2830 11 20 20	Traseira	LED 24V	Acabamento central Infinite	Conector 200 
2810 11 20 20	Frontal		Lanterna Light Bar	

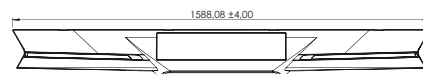
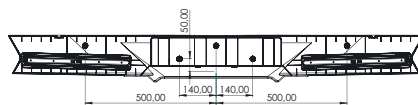
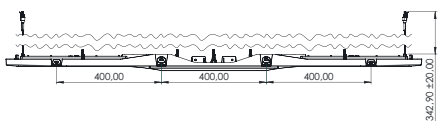



EUROLINE

Iluminação de montagem dinâmica

Caracterizada por suas formas dinâmicas, a família de lanternas Euroline permite a criação de assinaturas luminosas únicas, customizáveis pelo cliente.

Os produtos dessa linha podem ser aplicados de forma flexível: com uma simples rotação, uma nova assinatura é criada.



Euro 1

Lanterna traseira posição e freio



Disponível chicote 303



Código	Cód. Original	Fixação	Tensão	Conexão
2740 02 30 2A	Marcopolo: 12758563 Caio: 0221.0110.001	Frontal	LED BIVOLT	3 vias selado
2740 02 30 2B	Marcopolo: 12758433 Caio: 0221.0111.001			



Versão A



Versão B

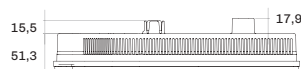
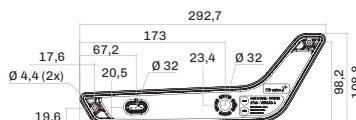



Euro 1

Lanterna traseira decorativa



Código	Cód. Original	Fixação	Cor	Tensão	Observação
2740 11 90 2A	Marcopolo: 12758495	Frontal	Vermelho	-	Sem iluminação
2740 11 90 2B	Marcopolo: 12758566				

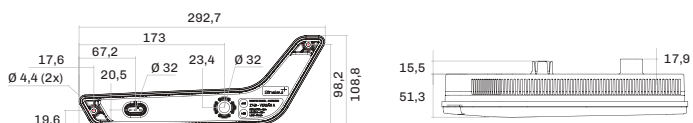

Euro 2 - Versões A/B

Lanterna traseira direcional e ré



Código	Fixação	Cor	Função	Tensão	Conexão
2535 31X 30 4A	Frontal	Cristal	Direcional e ré	LED BIVOLT	3 vias selado
2545 31X 30 4B					

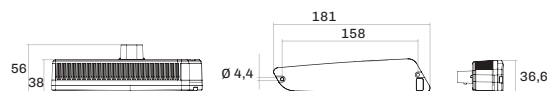

Euro 2 - Versão A

Lanterna traseira



Código	Cód. Original	Fixação	Cor	Função	Tensão	Conexão
2530 02X 30 2A	Rodofort: 4001191 Busscar: 62.334944	Frontal	Vermelha	Posição e freio		3 vias selado
2531 01X 30 4A	Rodofort: 4001192 Busscar: 62.334929 Comil: 964174 Marcopolo: 12758436		Cristal	Direcional	LED BIVOLT	2 vias selado
2532 03X 30 4A	Rodofort: 4001193 Busscar: 62.334957			Ré		

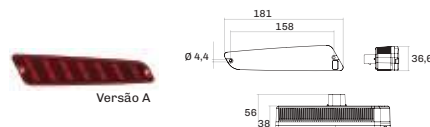





Euro 2 - Versão B

Lanterna traseira



Código	Cód. Original	Fixação	Cor	Função	Tensão	Conexão
2540 02X 30 2B	Rodofort: 4001230 Busscar: 62.334957		Vermelha	Posição e freio		3 vias selado 
2541 01X 30 4B	Rodofort: 4001231 Busscar: 62.334916 Comil: 964172 Marcopolo: 12758508	Frontal	Cristal	Direcional	LED BIVOLT	2 vias selado 
2542 03X 30 4B	Rodofort: 4001232 Busscar: 62.334893			Ré		



Versão B

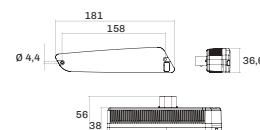

Euro 3

Lanterna traseira direcional e ré



Código	Fixação	Tensão	Cor	Função	Conexão
2750 31 30 4A	Traseira	LED BIVOLT	Cristal	Direcional e ré	3 vias selado 
2750 31 30 4B					



Versão A



Versão B

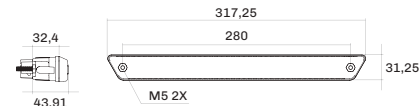

Euro 3

Lanterna traseira direcional sequencial e ré



Código	Fixação	Tensão	Cor	Função	Conexão
2750 31 60 4A	Traseira	LED BIVOLT	Cristal	Direcional e ré	3 vias selado 
2750 31 60 4B					



Versão A



Versão B

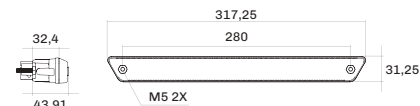

Caso o produto seja instalado na vertical, deve-se usá-lo sem direcional sequencial.



Euro 3

Lanterna traseira posição e freio



ECE



IP69K

CONTRAN

ORIGINAL

Código	Cód. Original	Fixação	Tensão	Cor	Função	Conexão
2750 38 60 2T	Mascarello: 590974	Traseira	LED BIVOLT	Cristal	Direcional e ré	3 vias selado 

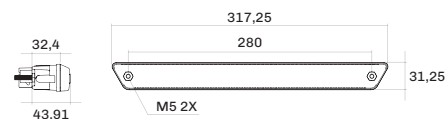

Aplicação: São Pedro e Vilaços

2750 31 60 4A/B



Conjunto traseiro Euro com direcional sequencial e com lateral



Disponível chicotes 215 e 305



ECE

ORIGINAL

Código	Lado	Fixação	Tensão	Conexão
2763 06 90 5 D	Direita	Traseira	LED BIVOLT	5 vias selado 
2763 06 90 5 E	Esquerda			

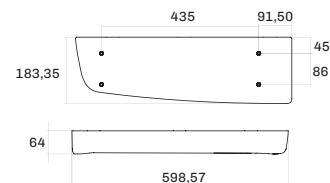

2750 31 60 4A/B



Conjunto traseiro Euro com direcional sequencial sem lateral



Disponível chicotes 215 e 305



ECE

ORIGINAL

Código	Lado	Fixação	Tensão	Conexão
2761 06 90 5 D	Direita	Traseira	LED BIVOLT	5 vias selado 
2761 06 90 5 E	Esquerda			

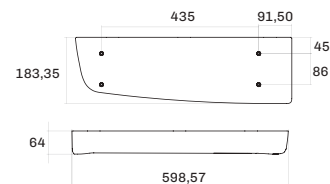



Carcaça do conjunto traseiro Euro



Código	Lado	Fixação
3201 00 90 6 D	Direita	Traseira
3201 00 90 6 E	Esquerda	

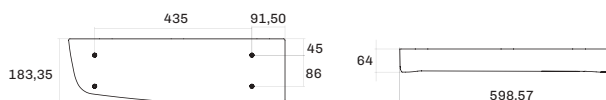

Módulo R

Lanternas traseira multifunção LED



Código	Fixação	Tensão	Observação	Conexão
2350	Traseira (Original)	LED BIVOLT	Direcional padrão	5 vias selado + auxiliares
2350 24		LED 24V		
2351	Traseira (Original)	LED BIVOLT	Direcional sequencial	5 vias selado + auxiliares
2351 24		LED 24V		
2351 06 60 50	Traseira (Original)	LED BIVOLT	Flashing	5 vias selado + auxiliares
2351 06 50 50		LED 24V		

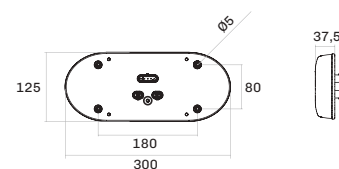

NOVO



Módulo R Red

Lanternas traseira multifunção LED com direcional sequencial



Código	Fixação	Tensão	Observação	Conexão
2352 06 60 20	Traseira (Original)	LED BIVOLT	Direcional padrão	5 vias selado + auxiliares
2352 06 50 20		LED 24V		

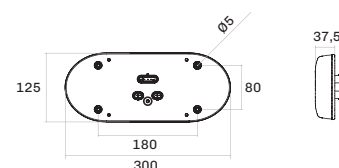

Intercambiável com conjuntos Randon 2011+



Conjunto traseiro R



Código	Lado	Fixação	Tensão	Observação	Conexão
2360 06 32 5 D	Direita	Superior	LED BIVOLT	Direcional padrão	5 vias selado + auxiliares
2360 06 32 5 E	Esquerda				
2361 06 32 5 D	Direita	Traseira			
2361 06 32 5 E	Esquerda				
2360 06 22 5 D	Direita	Superior	LED 24V	Direcional padrão	5 vias selado + auxiliares
2360 06 22 5 E	Esquerda				
2361 06 22 5 D	Direita	Traseira			
2361 06 22 5 E	Esquerda				
2360 06 62 5 D	Direita	Superior	LED BIVOLT	Direcional sequencial	5 vias selado + auxiliares
2360 06 62 5 E	Esquerda				
2361 06 62 5 D	Direita	Traseira			
2361 06 62 5 E	Esquerda				
2360 06 52 5 D	Direita	Superior	LED 24V	Direcional sequencial	5 vias selado + auxiliares
2360 06 52 5 E	Esquerda				
2361 06 52 5 D	Direita	Traseira			
2361 06 52 5 E	Esquerda				

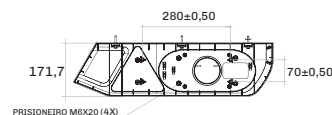

Fixação traseira

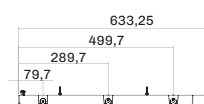

Fixação superior



Conjunto traseiro R Red com direcional sequencial



Código	Lado	Fixação	Tensão	Observação	Conexão
2362 06 60 2 D	Direita	Superior	LED BIVOLT	Direcional sequencial	5 vias selado + auxiliares
2362 06 60 2 E	Esquerda				
2363 06 60 2 D	Direita	Traseira			
2363 06 60 2 E	Esquerda				
2362 06 50 2 D	Direita	Superior	LED 24V	Direcional sequencial	5 vias selado + auxiliares
2362 06 50 2 E	Esquerda				
2363 06 50 2 D	Direita	Traseira			
2363 06 50 2 E	Esquerda				

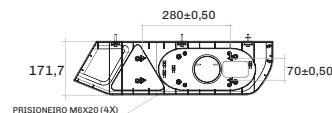

Fixação traseira

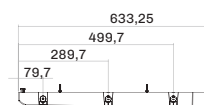

Fixação superior



Carcaça do conjunto traseiro *R*

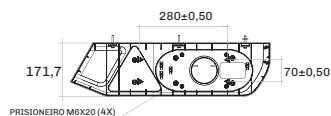

Fixação traseira

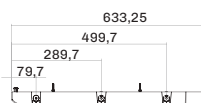

Fixação superior

Código	Lado	Fixação
3360 00 90 6 D	Direita	Superior
3360 00 90 6 E	Esquerda	Superior
3361 00 90 6 D	Direita	Traseira
3361 00 90 6 E	Esquerda	Traseira



Disponível chicotes
215 e 305



Turn

Lanterna traseira multifunção LED com direcional sequencial, posição dupla e guia de luz

Código	Fixação	Tensão	Observação	Conexão
2235	Traseira	LED BIVOLT	Guia de luz	5 vias selado + auxiliares
2236	Traseira	LED BIVOLT	Direcional sequencial, posição dupla e guia de luz	5 vias selado + auxiliares
2238 24		LED 24V	Direcional sequencial, posição dupla e guia de luz *Melhor custo-benefício	5 vias selado + auxiliares
2237 24	Traseira	LED 24V	Posição dupla e guia de luz	5 vias selado + auxiliares
2236 06 30 50	Traseira	LED BIVOLT	Posição dupla, guia de luz e sistema Flashing	5 vias selado + auxiliares
2238 06 50 50		LED 24V	Posição dupla, guia de luz e sistema Flashing	5 vias selado + auxiliares

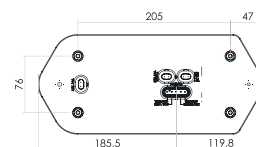
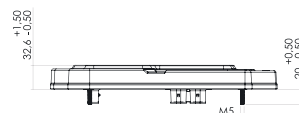

NOVO



Conjunto traseiro Turn

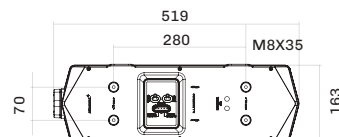

Fixação traseira

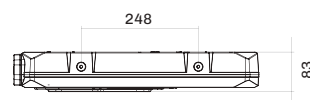

Fixação superior

Código	Lado	Fixação	Tensão	Observação	Conexão
2729 1 24 D	Direita	Superior	LED 24V	Posição dupla e guia de luz	5 vias selado + auxiliares
2729 1 24 E	Esquerda				
2729 2 24 D	Direita	Traseira	LED 24V		
2729 2 24 E	Esquerda				
2727 1 D	Direita	Superior	LED BIVOLT	Guia de luz	5 vias selado + auxiliares
2727 1 E	Esquerda				
2727 2 D	Direita	Traseira	LED BIVOLT		
2727 2 E	Esquerda				
2728 1 D	Direita	Superior	LED BIVOLT	Direcional sequencial, posição dupla e guia de luz	5 vias selado + auxiliares
2728 1 E	Esquerda				
2728 2 D	Direita	Traseira	LED BIVOLT		
2728 2 E	Esquerda				
2730 1 24 D	Direita	Superior	LED 24V	Direcional sequencial, posição dupla e guia de luz *Melhor custo-benefício	5 vias selado + auxiliares
2730 1 24 E	Esquerda				
2730 2 24 D	Direita	Traseira	LED 24V		
2730 2 24 E	Esquerda				



Carcasa do conjunto traseiro Turn



Código	Lado	Fixação
2726 1 D	Direita	Superior
2726 1 E	Esquerda	
2726	-	Traseira



One

Conjunto traseiro LED



Código	Lado	Fixação	Tensão	Conexão
1000 06 30 5 D	Direita	Superior ou traseira	LED BIVOLT	5 vias selado
1000 06 30 5 E	Esquerda			

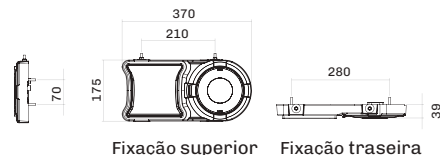

Two

Conjunto traseiro LED



Código	Lado	Fixação	Tensão	Conexão
2083 06 30 D	Direita	Superior ou traseira	LED BIVOLT	6 vias FASTON
2083 06 30 E	Esquerda			
2086 06 30 5 D	Direita	Superior ou traseira	LED BIVOLT	5 vias selado
2086 06 30 5 E	Esquerda			

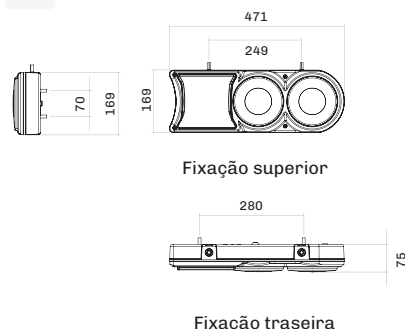

Circle Light

Conjunto traseiro LED



Código	Lado	Fixação	Tensão	Conexão
2080 0 D	Direita	Superior ou traseira	LED BIVOLT	6 vias FASTON
2080 0 E	Esquerda			
2081 06 30 5 D	Direita	Superior ou traseira	LED BIVOLT	5 vias selado
2081 06 30 5 E	Esquerda			

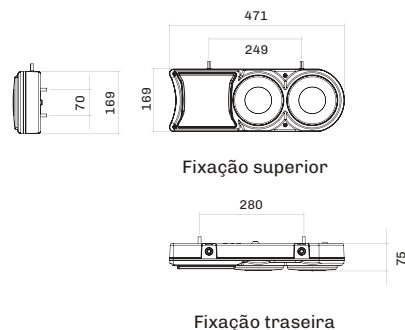



2131

2132

300

Circle Light

Conjunto traseiro LED com lentes cristal

Disponível chicotes
215 e 305

Código	Lado	Fixação	Tensão	Conexão
2180 0 D	Direita	Superior ou traseira	LED BIVOLT	6 vias FASTON
2180 0 E	Esquerda			

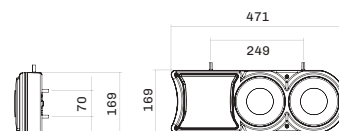

Fixação superior

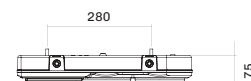

Fixação traseira



Carcaça conjunto traseiro Circle Light e Two



Código	Fixação
2087	Superior ou traseira

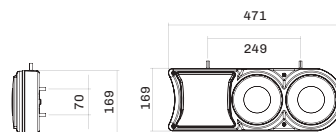

Fixação superior

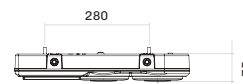

Fixação traseira



Lanterna traseira LED Ø135mm posição, freio, direcional e ré

Disponível chicotes
215 e 305

Código	Fixação	Tensão	Conexão
2038 06 30 50	Traseira	LED BIVOLT	5 vias selado

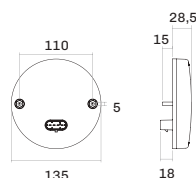



Lanterna traseira LED Ø135mm posição, freio e direcional



Código	Fixação	Tensão	Observação	Conexão
2031 206	Traseira	LED BIVOLT	Inclui chicote 206	4 vias selado 
2031			Sem chicote 206	-

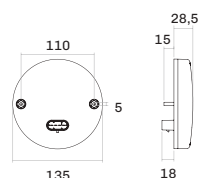

Lanterna traseira LED Ø135mm posição, freio e ré



Código	Fixação	Tensão	Observação	Conexão
2032 206	Traseira	LED BIVOLT	Inclui chicote 206	4 vias selado 
2032			Sem chicote 206	-

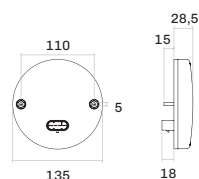

Lanterna traseira LED Ø135mm posição, freio e direcional



Código	Fixação	Tensão	Observação	Conexão
2131 206	Traseira	LED BIVOLT	Inclui chicote 206	4 vias selado 

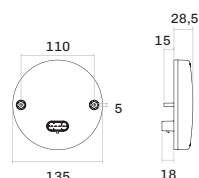



Lanterna traseira LED Ø135mm posição, freio e ré



Código	Fixação	Tensão	Observação	Conexão
2132 206	Traseira	LED BIVOLT	Inclui chicote 206	4 vias selado 

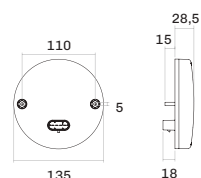

2071 CR 2071 VM 2071 VM 2071 AM

Conjunto traseiro LED para cegonheira



Código	Lado	Fixação	Tensão	Conexão
2202 124 3 D	Direita	Superior	LED 24V	6 vias FASTON 
2202 124 3 E	Esquerda			
2202 2 24 3	-	Traseira		

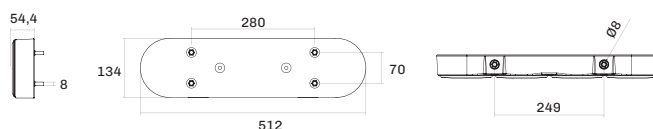

Coruja LED

Lanterna traseira



Código	Lado	Fixação	Tensão	Conexão
7000 D	Direita	Superior	LED BIVOLT	6 vias FASTON 
7000 E	Esquerda			
7001 D	Direita	Traseira		
7001 E	Esquerda			

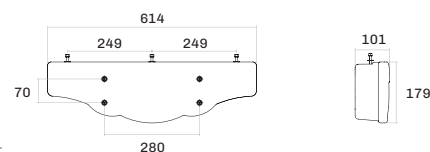

707 D - Lente

707 E - Lente



Coruja

Lanterna traseira



Código	Lado	Fixação	Conexão
7007 SL D	Direita	Superior	6 vias FASTON 
7007 SL E	Esquerda		
7017 SL D	Direita	Traseira	
7017 SL E	Esquerda		
707 D - Lente	Direita		
707 E - Lente	Esquerda		

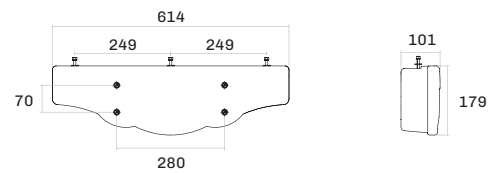

Canoinha

Lanterna traseira



Código	Fixação	Conexão
1104 BI	Traseira	Fios
104 BI - Lente		



Lanterna traseira multifunção



Código	Fixação	Observação	Conexão
1129 R	Traseira	3 lentes, sem ré	Fios
1130 R		4 lentes, com ré	
118 R - Lente			



Canoinha

Lanterna multifunção LED posição, freio, direcional e ré



Código	Fixação	Tensão	Conexão
2120 24		LED 24V	4 vias selado 
2120 12	Traseira	LED 12V	
2130 12			Fios

- Fios navais estanhados 0,50mm ✓
- Parafusos resistentes a corrosão ✓
- De acordo com o Contran 667/17 ✓
- Resistente a imersão IP67 ✓

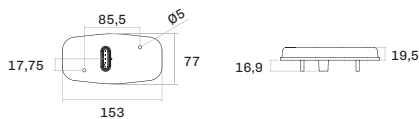

Canoinha

Lanterna multifunção LED posição, freio e direcional



Código	Fixação	Tensão	Conexão
2121 24		LED 24V	4 vias selado 
2121 12	Traseira	LED 12V	
2133 12			Fios

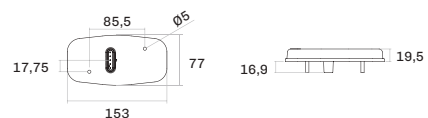



Brake Light

Lanterna LED com iluminação indireta



Código	Cód. Original	Fixação	Tensão	Conexão
2095 VM	Mascarello: 047057 Busscar: 62.290838	Frontal	LED BIVOLT	2 vias selado 
2096 VM	-			2 vias FASTON 2,8 

Iluminação indireta:

O brake light SINALSUL possui iluminação com refletor indireto resultando uma maior homogeneidade visual do produto em funcionamento, pois os pontos de luz não ficam aparentes.

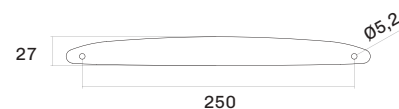

Luz traseira



Código	Fixação	Tensão	Função / cor	Conexão
2821 10X 30 2T	Frontal	LED BIVOLT	Nebliina - Vermelha	2 vias selado 
2821 03 30 4T	Frontal	LED BIVOLT	Ré - Cristal	2 vias selado  NOVO

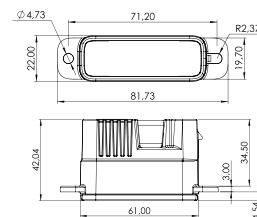

Lanterna traseira LED Ø83mm ré, posição e freio



Código	Fixação	Tensão	Função	Conexão
2492 18 30 4T	Traseira	LED BIVOLT		4 vias selado 

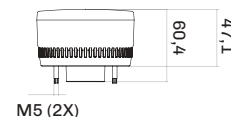
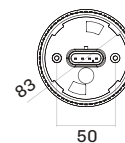



Lanterna traseira LED Ø83mm direcional, posição e freio



Código	Cód. Original	Fixação	Tensão	Função	Conexão
2491 17 30 4T	Marcopolo: 11895664 Volare: 11895664	Traseira	LED BIVOLT		4 vias selado

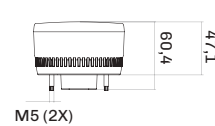
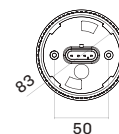

Lanterna traseira LED Ø125mm



Código	Fixação	Tensão	Cor e Função	Conexão
2009 AM	Traseira		Amarela Direcional	2 vias FASTON
2009 CR	Traseira	LED BIVOLT	Cristal Ré	
2008 VM	Traseira		Vermelha Posição e freio	3 vias FASTON



Foto do produto ligado

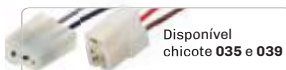

Código	Fixação	Tensão	Cor e Função	Conexão
2171 24 AM	Frontal	LED 24V	Cristal Direcional	2 vias FASTON
2171 24 VM	Frontal		Cristal Posição e freio	3 vias FASTON



Foto do produto ligado

Disponível
chicote 035 e 039

Lanterna traseira LED Ø125mm

Código	Fixação	Tensão	Cor e Função	Conexão
2070 24 AM			Amarela Direcional	2 vias FASTON 
2070 24 CR	Traseira	LED 24V	Cristal Ré	
2070 24 VM			Vermelha Posição e freio	3 vias FASTON 



Foto do produto ligado

Disponível
chicote 035 e 039

Lanterna traseira LED Ø125mm

Código	Cód. Original	Fixação	Tensão	Cor e Função	Conexão
2071 24 AM	Marcopolo: 134899 Mascarello: 093492			Amarela Direcional	2 vias FASTON 
2071 24 CR	Marcopolo: 88971 Mascarello: 093494	Frontal	LED 24V	Cristal Ré	
2071 24 VM	Marcopolo: 88969 Mascarello: 087591			Vermelha Posição e freio	3 vias FASTON 



ECE

CONTRAN

Lanterna traseira Ø125mm

Código	Fixação	Cor	Conexão
1207 AM		Amarela	
1207 VM	Frontal	Vermelha	Soquete 027, 028, 037, 038
1207 CR		Cristal	



Lanterna traseira ré com retrorefletor Ø125mm Randon 2002-2009



Código	Cód. Original	Fixação	Conexão
1392 BC	213000114	Traseira	Soquete 027, 037



Lanterna traseira Ø125mm para conjuntos Randon 2002-2009



Código	Cód. Original	Fixação	Cor e Função	Conexão
1391 AM	213000113		Amarela Direcional	Soquete 027
1391 CR	-	Traseira	Cristal Ré	
1391 VM	213000112		Vermelha Posição e freio	Soquete 028



Lanterna traseira ré com retrorefletor Ø125mm Randon 2000-2001



Código	Cód. Original	Fixação	Conexão
1143 BC	210102064	Traseira	Soquete 027



Lanterna traseira Ø125mm conjuntos Randon 2000-2001



Código	Cód. Original	Fixação	Conexão
1141 AM	210102062		
1141 VM	-	Traseira	Soquete 027
1141 CR	-		



Lanterna traseira Guerra



Código	Fixação	Cor	Conexão
1204 AM		Amarela	Soquete 027
1204 CR	Traseira	Cristal	
1204 VM		Vermelha	Soquete 028



Lanterna traseira Guerra



Código	Cód. Original	Fixação	Cor	Conexão
1180 AM	5001009213001		Amarela	Soquete 027
1180 CR	5001009154009	Traseira	Cristal	
1181 VM	5001009211008		Vermelha	Soquete 028



Lanterna traseira/dianteira Ø95mm Marcopolo



Código	Cód. Original	Fixação	Cor	Conexão
1292 AM	2620 1127		Amarela	
1292 VM	2620 1126	Frontal	Vermelha	Soquete 091, 092
1292 CR	2620 1128		Cristal	



Foto do produto ligado

Disponível
chicote 035 e 039

Lanterna traseira LED Ø155mm Marcopolo, Busscar e Ciferal

Código	Fixação	Tensão	Cor e Função	Conexão
2074 24 AM			Amarela Direcional	2 vias FASTON 
2074 24 CR	Frontal	LED 24V	Cristal Ré	
2074 24 VM			Vermelha Posição e freio	3 vias FASTON 

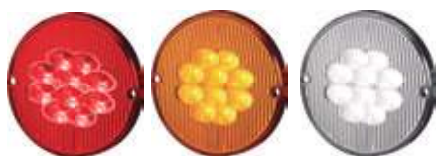
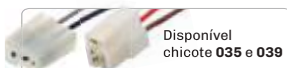

Foto do produto ligado

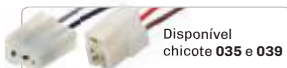
Disponível
chicote 035 e 039

Lanterna traseira LED Ø155mm Noma com fixação traseira

Código	Fixação	Tensão	Cor e Função	Conexão
2072 24 AM		LED 24V	Amarela Direcional	2 vias FASTON 
2072 12 AM	Traseira	LED 12V		
2072 24 CR		LED 24V	Cristal Ré	2 vias FASTON 
2072 12 CR	Traseira	LED 12V		
2072 24 VM		LED 24V	Vermelha Posição e freio	3 vias FASTON 
2072 12 VM	Traseira	LED 12V		



Lanterna LED Ø75mm



Disponível
chicote 200



Código	Cód. Original	Fixação	Tensão	Cor e Função	Conexão	
2290 24	Caio: 2.210.092.001 Marcopolo: 10836619	Frontal	LED 24V	Cristal Ré	2 vias selado	
2290 12	-		LED 12V			
2291 24	Caio: 2.210.092.002	Frontal	LED 24V	Amarela Direcional	2 vias selado	
2291 12	-		LED 12V			
2292 24	-	Frontal		Vermelha Posição e freio	2 vias selado	
2292 12	-					

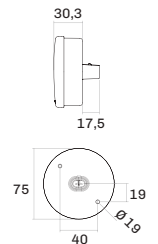

Fixação frontal



Lanterna LED Ø75mm



Disponível
chicote 200



Código	Cód. Original	Fixação	Tensão	Cor e Função	Conexão	
2190 24	Marcopolo: 10469280 Volare: 10469280 Mascarello: 093496	Traseira	LED 24V	Cristal Ré	2 vias selado	
2190 12	Marcopolo: 10912087		LED 12V			
2191 24	Mascarello: 093489	Traseira	LED 24V	Amarela Direcional	2 vias selado	
2191 12	Marcopolo: 10912087		LED 12V			
2192 24	Mascarello: 175532 Marcopolo: 11519742	Traseira		Vermelha Posição e freio	2 vias selado	
2192 12	-					

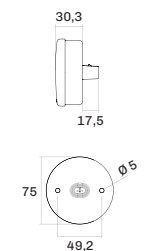

Fixação traseira



2011 2070 2070 1392 2070

*Ré em lâmpada



Conjunto traseiro Randon LED

Código	Lado	Fixação	Tensão	Observação	Conexão
2024 24 D	Direita			Sem aba	
2024 24 E	Esquerda				
2023 24 D	Direita	Superior	LED 24V		6 vias FASTON 
2023 24 E	Esquerda			Com aba	



2011 2070 299 2070 1391 CR

*Ré em lâmpada



Conjunto traseiro Randon LED com triângulo retrorrefletor

Código	Lado	Fixação	Tensão	Observação	Conexão
2024 24 299 D	Direita			Sem aba	
2024 24 299 E	Esquerda				
2023 24 299 D	Direita	Superior	LED 24V		6 vias FASTON 
2023 24 299 E	Esquerda			Com aba	



2011 2009 2008 2020 BC 2008



Conjunto traseiro universal LED

Código	Lado	Fixação	Tensão	Observação	Conexão
2007 D	Direita			Sem aba	
2007 E	Esquerda				
2006 D	Direita	Superior	LED BIVOLT		6 vias FASTON 
2006 E	Esquerda			Com aba	



2011 2009 299 2008 2009

Conjunto traseiro universal LED com triângulo retrorrefletor



Código	Lado	Fixação	Tensão	Observação	Conexão
2006 299 D	Direita	Superior	LED BIVOLT	Sem aba	6 vias FASTON 
2006 299 E	Esquerda				



1145 1391 1391 1392 1391

*Lâmpadas não inclusas

Conjunto traseiro Randon 2002 - 2009



Código	Cód. Original	Lado	Fixação	Observação	Conexão
1390 SL D	210102691-P	Direita		Sem aba	
1390 SL E	210102692-P	Esquerda			
1389 SL D	210102695-P	Direita	Superior		6 vias FASTON 
1389 SL E	210102696-P	Esquerda		Com aba	



1145 1141 1141 1143 1141

*Sem lâmpadas

Conjunto traseiro Randon 2000 - 2001



Código	Cód. Original	Lado	Fixação	Observação	Conexão
1157 SL D	210102003-P	Direita		Sem aba	
1157 SL E	210102004-P	Esquerda			
1147 SL D	210102001-P	Direita	Superior		6 vias FASTON 
1147 SL E	210102002-P	Esquerda		Com aba	



Carcapa dos conjuntos traseiros Randon



Código	Lado	Fixação	Observação
1156 D	Direita	Superior	Sem aba
1156 E	Esquerda		Sem aba
1155 D	Direita		Com aba
1155 E	Esquerda		Com aba



1163 1204 1204 1204 1204

*Sem lâmpadas

Conjunto traseiro Guerra



Código	Lado	Fixação	Observação	Conexão
1202 SL D	Direita	Superior	Sem aba	6 vias FASTON 
1202 SL E	Esquerda			



1163 1180 1181 1181 1180

*Sem lâmpadas

Conjunto traseiro Guerra



Código	Cód. Original	Lado	Fixação	Observação	Conexão
1200 SL D	5001009206009	Direita	Superior	Sem aba	6 vias FASTON 
1200 SL E	5001009207000	Esquerda			



Carcapa do conjunto traseiro Guerra



Código	Lado	Fixação
1201 SL D	Direita	Superior
1201 SL E	Esquerda	



Delimitadoras e laterais





Wide

Lanternas de posição lateral LED com retrorefletor e suporte



Código	Fixação	Tensão	Cor	Conexão
2610 07 31 10			Amarela	
2610 07 31 20	Superior	LED BIVOLT	Vermelha	2 vias selado
2610 07 31 40			Cristal	

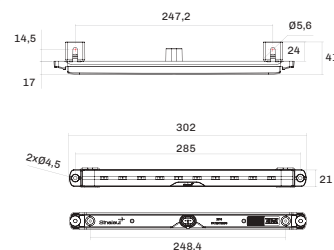

Wide

Lanternas de posição lateral LED com retrorefletor



Código	Fixação	Tensão	Cor	Conexão
2610 07 30 10			Amarela	
2610 07 30 20	Superior	LED BIVOLT	Vermelha	2 vias selado
2610 07 30 40			Cristal	

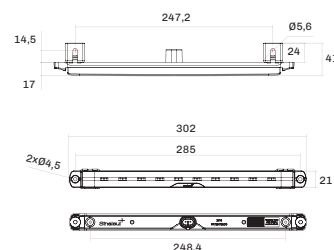

Aplicação: São Pedro e Palmeira

Lanternas de posição lateral LED com retrorefletor e suporte



Código	Fixação	Tensão	Cor	Observação	Conexão
2660 07 30 10			Amarela		
2660 07 30 20	Superior	LED BIVOLT	Vermelha	-	2 vias selado
2660 07 30 30			Verde		
2660 07 30 40			Cristal		
2661 08 30 10	Superior	LED BIVOLT	Amarela	ECE CAT 5	2 vias selado

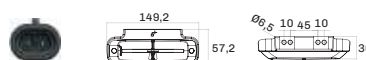

DIRECIONAL CATEGORIA 5

As lanternas laterais **2661** e **2665**, além de luz de posição, possuem um LED adicional para a função direcional que é acionado junto com a lanterna traseira. Ou seja, quando o motorista liga o pisca, todas as lanternas laterais do implemento piscam em conjunto. Para atendimento da norma resolução **CONTRAN 761** é necessário o uso do módulo **0120 00 30 60 (p. 111)**

2665, 2661
Com LED adicional para CAT5

2660, 2664
Somente luz de posição





Lanterna de posição lateral LED com retrorefletor



Código	Cód. Original	Fixação	Tensão	Cor	Observação	Conexão
2664 07 30 10	Comil: 951494			Amarela		
2664 07 30 20	Comil: 186044	Frontal	LED BIVOLT	Vermelha	Sem EVA	2 vias selado 
2664 07 30 30	-			Verde		
2664 07 30 40	-			Cristal		
2665 08 30 10	-	Frontal	LED BIVOLT	Amarela	Sem EVA ECE CAT 5	2 vias selado 
2664 07 31 10	-			Amarela		
2664 07 31 20	-	Frontal	LED BIVOLT	Vermelha	Com EVA	2 vias selado 
2664 07 31 30	-			Verde		
2664 07 31 40	-			Cristal		
2664 07 21 10	Irizar: 8029254BR Marcopolo: 12728164 Volare: 12728164	Frontal	LED 24V	Amarela	Com EVA	2 vias selado 

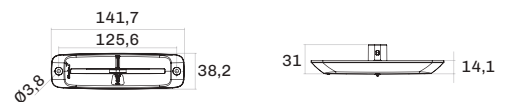

Lanterna de posição lateral LED com retrorefletor



Código	Cód. Original	Fixação	Tensão	Cor	Base	Observação	Conexão
2680 07 30 10	Caio: 2.210.073.001	Frontal	LED BIVOLT	Amarela	Branca	Sem EVA	2 vias selado 
2680 07 30 20	Caio: 2.210.073.002			Vermelha	Branca		
2680 07 31 10	-	Frontal	LED BIVOLT	Amarela	Preta	Com EVA	2 vias selado 

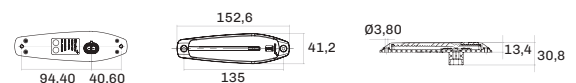



Lanterna de posição lateral e direcional LED com retrorrefletor



Código	Cód. Original	Fixação	Tensão	Cor	Base	Observação	Conexão
2670 08 30 10	Caio: 2.210.072.001 Comil: 951486		LED BIVOLT	Amarela	Branca	Sem EVA	
2670 08 21 10	Irizar: 8029255BR Marcopolo: 12728144 Volare: 12728144	Frontal	LED 24V	Vermelha	Branca	Com EVA	3 vias selado 
2670 08 32 10	Busscar: 62.551.121		LED BIVOLT	Amarela	Preta		

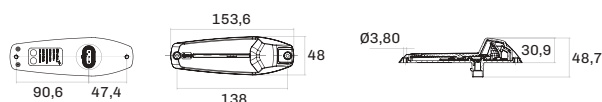

Lanterna direcional e posição lateral LED com retrorrefletor R6



Código	Cód. Original	Fixação	Tensão	Observação	Conexão
2036 AM	Caio: 2.210.061.001 Comil: 756755	Frontal	LED BIVOLT	-	3 vias selado 
2036 24 AM	Mascarello: 93499 Caio: 2.210.061.002		LED 12V		
2036 124 AM	Marcopolo: 11109709 Volare: 11109709	Frontal	LED BIVOLT	Sem vedação	3 vias selado 





*Homologação ECE na função Posição lateral (AM)

Lanterna de posição LED com guia de luz e retrorrefletor R7



Disponível chicote 200



Código	Cód. Original	Fixação	Tensão	Cor	Observação	Conexão
2056	Comil (AM): 756767 Marcopolo: 11110175 Volare: 11110175 Caio: 2.210.062.002	Frontal	LED BIVOLT	Vermelha Cristal Amarela Verde	-	2 vias selado
2056 3	-					Fios
2056 5 AM	Caio: 2.210.062.001	Frontal	LED BIVOLT	Amarela	Guia de luz e EVA	2 vias selado

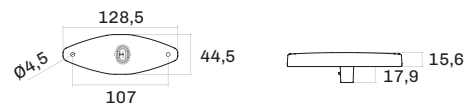

*Homologação ECE na função Posição lateral (AM)

Lanterna de posição LED com guia de luz e retrorrefletor e suporte R7



Disponível chicote 200



Código	Fixação	Tensão	Cor	Conexão
2056 2 AM			Amarela	
2056 2 VM	Superior	LED BIVOLT	Vermelha	2 vias selado
2056 2 CR			Cristal	
2056 2 VD			Verde	
2056 4 AM			Amarela	
2056 4 VM	Superior	LED BIVOLT	Vermelha	Fios
2056 4 CR			Verde	
2056 4 VD			Cristal	

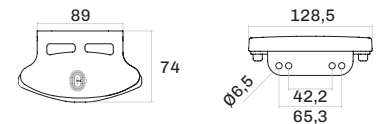



*Homologação ECE na função Posição lateral (AM)

Elipse

Lanterna de posição LED com retrorrefletor



Código	Cód. Original	Fixação	Tensão	Cor	Conexão
2040 AM	Mascarello: 093501 Caio (AM): 2.210.093.001			Amarela	
2040 VM	-	Frontal	LED BIVOLT	Vermelha	2 vias selado 
2040 CR	-			Cristal	
2041 AM	-			Amarela	
2041 VM	-			Vermelha	
2041 CR	-	Frontal	LED BIVOLT	Verde	Fios
2041 VD	-			Cristal	

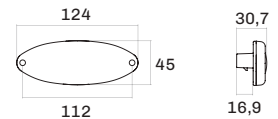

*Homologação ECE na função Posição lateral (AM)

Elipse

Lanterna de posição LED com retrorrefletor e suporte



Código	Fixação	Tensão	Cor	Conexão
2042 AM			Amarela	
2042 VM	Superior	LED BIVOLT	Vermelha	2 vias selado 
2042 CR			Cristal	
2042 VD			Verde	
2043 AM			Amarela	
2043 VM	Superior	LED BIVOLT	Vermelha	Fios
2043 CR			Verde	
2043 VD			Cristal	

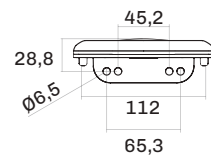



Suporte flexível



Código	Fixação	Observação
1164	Superior	Suporte para lanternas 2056, 2042, 2043



Lanterna de posição LED Dot Light Ø18mm



Código	Cód. Original	Fixação	Tensão	Observação	Conexão
2280 AM	-			Amarela	
2280 CR	-			Cristal	
2280 VM	Irizar: 8042204BR	Através da base	LED BIVOLT	Vermelha	Fios
2280 VD	-			Verde	
2280 11 30 80	Marcopolo: 11596646			Azul	

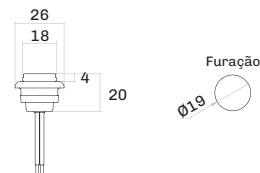



Joinha

Lanterna de posição LED com guia de luz e retrorrefletor



Disponível chicote 200



Código	Fixação	Tensão	Cor	Conexão
2048 AM	Fixação Turn	LED BIVOLT	Amarela	2 vias selado 
2049 AM	Traseira	LED BIVOLT	Amarela	2 vias selado 
2049 VM			Vermelha	
2049 CR			Cristal	
2049 VD			Verde	
2052 AM	Traseira	LED BIVOLT	Amarela	Fios
2052 VM			Vermelha	
2052 CR			Verde	
2052 VD			Cristal	

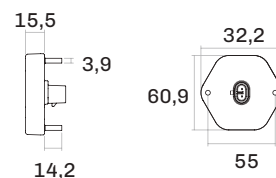

Joinha

Lanterna de posição LED com guia de luz e retrorrefletor com suporte



Disponível chicote 200



Código	Fixação	Tensão	Cor	Conexão
2055 AM	Superior	LED BIVOLT	Amarela	2 vias selado 
2055 VM			Vermelha	
2055 CR			Cristal	
2055 VD			Verde	

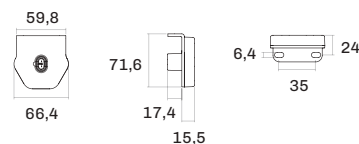



*Homologação ECE na função Dianteira (CR)



Joinha

Lanterna de posição LED com guia de luz e retrorrefletor

Código	Fixação	Tensão	Cor	Conexão
2057 AM	Frontal	LED BIVOLT	Amarela	2 vias selado
2057 VM			Vermelha	
2057 CR			Cristal	
2057 VD			Verde	

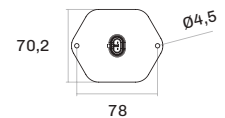
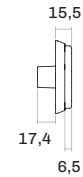

*Homologação ECE na função Posição lateral (AM) Dianteira (CR)

Lanterna de posição Ø88mm LED com retrorrefletor

Código	Fixação	Tensão	Cor	Observação	Conexão
2011 AM	Traseira	LED BIVOLT	Amarela	Homologado ECE	2 vias selado
2011 VM			Vermelha	-	
2011 CR			Cristal	Homologado ECE	
2011 VD			Verde	-	
2029 AM	Traseira	LED BIVOLT	Amarela	Homologado ECE	Fios
2029 VM			Vermelha	-	
2029 CR			Cristal	Homologado ECE	
2029 VD			Verde	-	

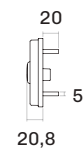



Lanterna de posição LED com retrorefletor e suporte



Disponível
chicote 200



ECE

*Homologação ECE na função
Posição lateral (AM) Dianteira (CR)

Código	Fixação	Tensão	Cor	Observação	Conexão
2059 AM	Traseira	LED BIVOLT	Amarela	Homologado ECE	2 vias selado 
2059 VM			Vermelha	-	
2059 CR			Cristal	Homologado ECE	
2059 VD			Verde	-	
2030 AM	Traseira	LED BIVOLT	Amarela	Homologado ECE	Fios
2030 VM			Vermelha	-	
2030 CR			Cristal	Homologado ECE	
2030 VD			Verde	-	

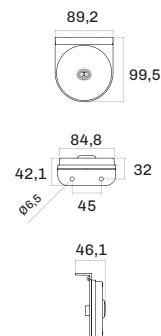

Lanterna de posição Ø65mm LED com retrorefletor



Disponível
chicote 200



ECE

*Homologação ECE na função
Posição lateral (AM) Dianteira (CR)

Código	Fixação	Tensão	Cor	Observação	Conexão
2044 AM	Traseira	LED BIVOLT	Amarela	Homologado ECE	2 vias selado 
2044 VM			Vermelha	-	
2044 CR			Cristal	Homologado ECE	
2044 VD			Verde	-	
2045 AM	Traseira	LED BIVOLT	Amarela	Homologado ECE	Fios
2045 VM			Vermelha	-	
2045 CR			Cristal	Homologado ECE	
2045 VD			Verde	-	

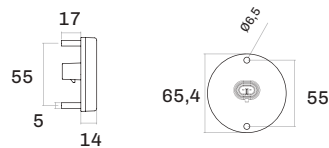



Lanterna de posição LED com retrorrefletor e suporte



*Homologação ECE na função Posição lateral (AM) Dianteira (CR)

Código	Fixação	Tensão	Cor	Conexão
2046 AM	Superior	LED BIVOLT	Amarela	2 vias selado
2046 VM			Vermelha	
2046 CR			Cristal	
2046 VD			Verde	
2047 AM	Superior	LED BIVOLT	Amarela	Fios
2047 VM			Vermelha	
2047 CR			Cristal	
2047 VD			Verde	

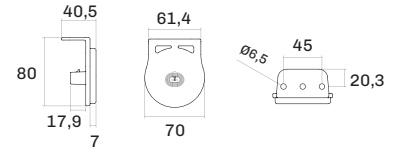

Lanterna de posição Ø65mm LED com retrorrefletor



Código	Fixação	Tensão	Cor	Conexão
2160 04 30 10	Frontal	LED BIVOLT	Amarela	2 vias selado
2160 04 30 20			Vermelha	
2160 04 30 40			Cristal	

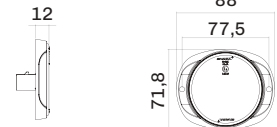

Código	Cód. Original	Fixação	Tensão	Cor	Lente	Conexão
2221 24 AM	10008322	Adesivo	LED 24V	Amarela	Cristal	2 vias selado
2222 24 VM	10334496			Vermelha	Vermelha	
2220 24 CR	10008604			Cristal	Cristal	



Lanterna de posição Ø88mm Randon com retrorrefletor



Código	Cód. Original	Fixação	Cor	Conexão
1145 PS AM	210102016	Traseira	Amarela	2 vias FASTON 
1145 PS VM	210102019		Vermelha	
1145 PS CR	-		Cristal	
1145 PS VD	210102020		Verde	

145 PS AM - Lente

145 PS VM - Lente

145 PS CR - Lente

145 PS VD - Lente



Lanterna de posição Ø88mm Randon com retrorrefletor e suporte

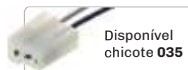

Código	Fixação	Cor	Conexão
1159 PS AM	Superior	Amarela	2 vias FASTON 
1159 PS VM		Vermelha	
1159 PS CR		Cristal	
1159 PS VD		Verde	

145 PS AM - Lente

145 PS VM - Lente

145 PS CR - Lente

145 PS VD - Lente



Lanterna de posição universal lente arredondada



Código	Cód. Original	Fixação	Tensão	Cor	Observação	Conexão
2066 AM	-	Frontal	LED BIVOLT	Amarela	Com EVA	2 vias selado 
2066 VM	-			Vermelha		
2066 CR	-			Cristal		
2066 VD	-			Verde		
2064 AM	-	Frontal	LED BIVOLT	Amarela	Com EVA	Fios e conector
2064 VM	Caio: 2.210.087.001			Vermelha		
2064 CR	Caio: 2.210.087.002 Busscar: 2.210.087.001			Cristal		
2064 VD	-			Verde		
2264 AM	-	Frontal	LED BIVOLT	Amarela	Sem EVA	Fios
2264 VM	-			Vermelha		
2264 CR	-			Cristal		
2264 VD	-			Verde		

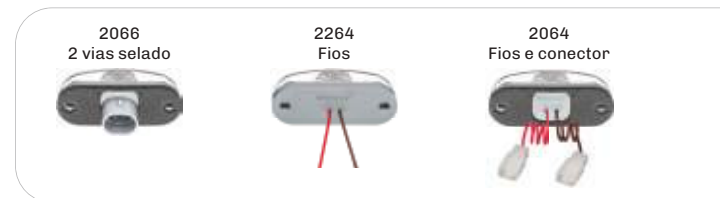
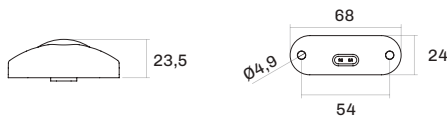

Lanterna de posição LED e retrorefletor Guerra com suporte





Código	Fixação	Tensão	Cor	Conexão
2034 AM	Superior	LED BIVOLT	Amarela	Fios
2034 VM			Vermelha	
2034 CR			Cristal	

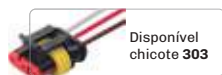

Pocket Dupla

Lanternas de posição traseira e direcional



Código	Fixação	Tensão	Observação	Conexão
2267 37 60 40	Frontal	LED BIVOLT	Direcional sequencial	Cabo PP 500mm e conector 3 vias selado 

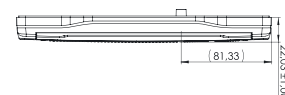
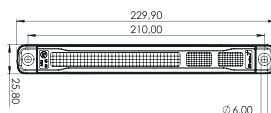

Pocket

Lanternas delimitadoras



Código	Fixação	Tensão	Cor	Conexão
2111 04 20 10	Frontal	LED 24V	Amarelo	Cabo PP chato 2 vias 300mm 
2111 04 20 2T			Vermelho	
2111 04 20 4F			Cristal	
2111 04 20 3F			Verde	

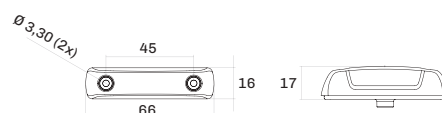



Lanterna de posição Ø88mm LED com retrorrefletor Guerra

Disponível
chicote 200

Código	Fixação	Tensão	Cor	Conexão
2012 AM			Amarela	
2012 VM	Traseira	LED BIVOLT	Vermelha	2 vias selado 
2012 CR			Cristal	
2033 AM			Amarela	
2033 VM	Traseira	LED BIVOLT	Vermelha	Fios
2033 CR			Cristal	



Lanterna de posição Ø88mm Guerra com retrorrefletor

Disponível
chicote 035

Código	Cód. Original	Fixação	Cor	Conexão
1165 PS AM	4059		Amarela	
1165 PS VM	-	Traseira	Vermelha	2 vias FASTON 
1165 PS CR	-		Cristal	
163 PS AM - Lente				
163 PS VM - Lente				
163 PS CR - Lente				



Suporte flexível para lanternas Ø88mm



Código	Fixação	Observação
1160	Superior	Suporte para lanternas 1149, 1145, 1163, 2012, 2033



Lanterna de posição



Código	Fixação	Cor	Observação	Conexão
1117 2 AM	Traseira	Amarela	Soquete interno	Fios
1117 2 VM		Vermelha		
1117 2 CR		Cristal		
1117 2 VD		Verde		

117 AM- Lente

117 VM- Lente

117 CR- Lente

A117 1 P - Aro preto



Lanterna de posição



Código	Fixação	Cor	Observação	Conexão
1117 1 AM	Traseira	Amarela	Soquete interno	Fios
1117 1 CR		Cristal		

117 AM- Lente

117 VM- Lente

117 CR- Lente

A117 1 P - Aro preto



Lanterna delimitadora LED



Código	Fixação	Tensão	Cor	Conexão
2016 AM			Amarela	
2016 VM	Traseira	LED BIVOLT	Vermelha	Fios
2016 CR			Cristal	
2016 VD			Verde	



Lanterna lateral refletiva LED



Código	Fixação	Tensão	Cor	Conexão
2039 AM			Amarela	
2039 VM	Traseira	LED BIVOLT	Vermelha	Fios
2039 CR			Cristal	



Lanterna lateral refletiva base reta



Código	Fixação	Cor	Observação	Conexão
1139 PS AM		Amarela	Soquete para lâmpada torped	
1139 PS VM	Traseira	Vermelha	Soquete para lâmpada torped	Fios
1139 PS CR		Cristal	Soquete para lâmpada torped	

122 PS AM - Lente



Lanterna de posição universal lente arredondada com retrorrefletor



Código	Fixação	Observação	Conexão
119 R AM	Traseira	1 polo	Fios

118 R AM - Lente



Lanterna de posição universal lente arredondada



Código	Fixação	Observação	Conexão
118 R AM			
118 R VM	Traseira	1 polo	Fios
118 R CR			

118 R AM - Lente

118 R VM - Lente

118 R CR - Lente



Lanterna de posição universal com suporte



Código	Fixação	Cor	Observação	Conexão
1120 R AM		Amarela		
1120 R VM	No suporte	Vermelha	Soquete 1 polo	Fios
1120 R CR		Cristal		

118 R AM - Lente

118 R VM - Lente

118 R CR - Lente



Lanterna delimitadora universal



Código	Fixação	Cor	Observação	Conexão
1138 AM		Amarela		
1138 VM	Traseira	Vermelha	1 polo	Fios
1138 CR		Cristal		

138 PS AM - Lente
 138 PS VM - Lente
 138 PS CR - Lente



Lanterna direcional e posição lateral com retrorrefletor Marcopolo



Código	Cód. Original	Fixação	Conexão
1195 037	99200731 ou 15201023		Soquete 1 polo 037
1195 038	99200730	Frontal	Soquete 2 polo 038
1195 AM	-		Sem soquete



Lanterna de posição lateral com retrorrefletor



Código	Cód. Original	Fixação	Conexão
1186 AM	-		Sem soquete
1186 C AM	26200678 6	Frontal	Soquete 051



Lanterna de posição lateral ônibus com retrorrefletor



Disponível
chicote 024



Código	Cód. Original	Fixação	Conexão
1124 ACR AM	37201043	Frontal	Soquete 024



Lanterna delimitadora



Disponível
chicote 200



ECE

Código	Cód. Original	Fixação	Tensão	Cor	Conexão
2440 04 3 2 1 0	Busscar: 62.378.028 Caio: 62.378.028			Amarela	
2440 04 3 2 2 0	Busscar: 62.378.015 Caio: 62.290.838	Frontal	LED BIVOLT	Vermelha	2 vias selado
2440 04 3 2 4 0	Busscar: 62.378002 Caio: 62.288.508			Cristal	

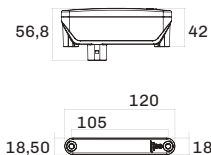

Lanterna delimitadora Ø70 mm



Disponível
chicote 200



Código	Cód. Original	Fixação	Tensão	Cor	Conexão
2078 AM	Caio: 0221.0081.001			Amarela	
2078 VM	-	Frontal	LED BIVOLT	Vermelha	2 vias selado
2078 CR	-			Cristal	



Lanterna delimitadora ônibus Ø70mm sem soquete



Disponível
chicote 036



CONTRAN

Código	Fixação	Cor	Conexão
1178 AM		Amarela	
1178 VM	Frontal	Vermelha	Sem soquete
1178 CR		Cristal	



Lanterna de posição lateral Marcopolo



Disponível
chicote 036



Código	Cód. Original	Fixação	Cor	Conexão
1199 AM	27202116-6	Frontal	Amarela	Sem soquete



Lanterna delimitadora Marcopolo G6



Disponível
chicote 017



ECE

CONTRAN

Código	Fixação	Cor	Observação	Conexões
1289 AM		Amarela		
1289 VM	Frontal	Vermelha	Sem soquete e sem lâmpada	2 conectores
1289 CR		Cristal		1 via FASTON 2,8 X 0,8
1289 VD		Verde		



Lanterna delimitadora Marcopolo G6



Código	Fixação	Cor	Conexão
1288 AM	Frontal	Amarela	Sem soquete e sem lâmpada
1288 VM		Vermelha	
1288 CR		Cristal	
1288 VD		Verde	



Lanterna delimitadora Marcopolo G6



Código	Cód. Original	Fixação	Cor	Conexão
1188C AM	Marcopolo: 15200422	Frontal	Amarela	Soquete 017
1188C VM	Marcopolo: 15200424		Vermelha	
1188C CR	Marcopolo: 15200423		Cristal	
1188C VD	Marcopolo: 15200421		Verde	



Lanterna delimitadora Marcopolo G5



Código	Cód. Original	Fixação	Cor	Conexão
1176 AM	10201285-2	Frontal	Amarela	Soquete 017
1176 VM	10201284-6		Vermelha	
1176 CR	10201283-0		Cristal	

176 AM - Lente

176 VM - Lente

176 CR - Lente



Lanterna delimitadora Recrusul

Código	Fixação	Cor	Conexão
1116 AM		Amarela	
1116 VM	Traseira	Vermelha	Soquete 017
1116 CR		Cristal	

116 AM - Lente
116 VM - Lente
116 CR - Lente



Lanterna delimitadora LED



Disponível chicote 200



Disponível suporte 1164



Código	Fixação	Tensão	Conexão
2480 04 30 40	Frontal	LED 24V	2 vias selado

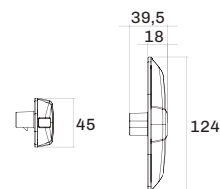

S-Flex

Lanterna delimitadora corneto LED



Código	Fixação	Tensão	Observação	Conexão
2486 04X 30 4D	Parafusos na base	LED BIVOLT	Sem sensor	Saída de cabo chato 2 vias
2486 04X 30 4E				

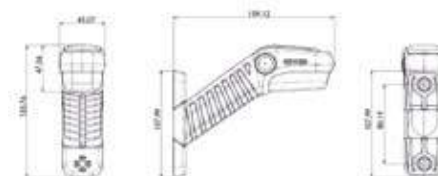



Iluminação Dianteira



Biled Ø90mm

Farol modular de luz alta e baixa LED Ø90mm

Disponível
chicote 0440

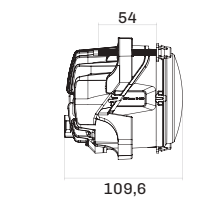
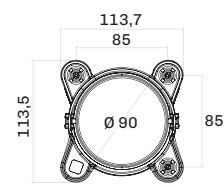

Código	Fixação	Tensão	Conexão
7090 32X 31 60	Traseira e frontal: M6 Curso de ajuste: 50mm	LED BIVOLT	3 vias HDSC

Simulação de distribuição de luz:

Luz baixa:

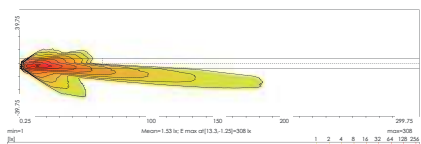

Luz alta:

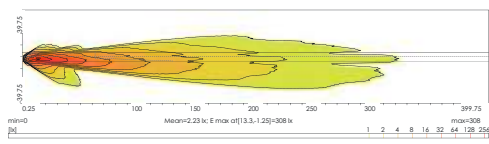

Simulações realizadas com dois faróis;
Altura dos faróis (chão): 0,6m;
Distância entre faróis: 1,5m;



Farol modular luz baixa LED Ø90mm

Disponível chicote 200

R149 IP69K CONTRAN ECE ORIGINAL

Código	Fixação	Tensão	Conexão
7091 33X 30 60	Traseira e frontal: M6 Curso de ajuste: 50mm	LED BIVOLT	2 vias selado

Simulação de distribuição de luz:

Luz baixa:

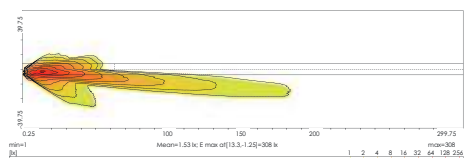

Simulações realizadas com dois faróis;
Altura dos faróis (chão): 0,6m;
Distância entre faróis: 1,5m;

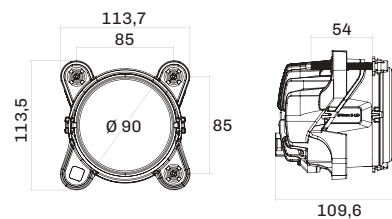

Farol modular luz alta LED Ø90mm

Disponível chicote 200

R149 IP69K CONTRAN ECE ORIGINAL

Código	Cód. Original	Fixação	Tensão	Conexão
7092 34X 30 60	Conjunto do Farol: 7500 06X 20 4D - A 9798201661 7500 06X 20 4E - A 9798201561	Traseira e frontal: M6 Curso de ajuste: 50mm	LED BIVOLT	2 vias selado

Simulação de distribuição de luz:

Luz alta:

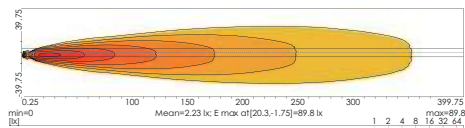

Simulações realizadas com dois faróis;
Altura dos faróis (chão): 0,6m;
Distância entre faróis: 1,5m;

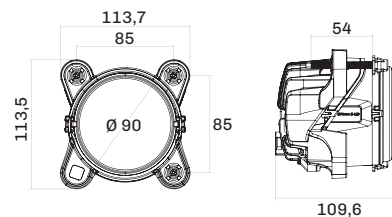



DRL (Daytime Running Light) posição e direcional dianteira LED Ø83mm



Código	Cód. Original	Fixação	Tensão	Função	Conexão
2490 16 30 4F	Marcopolo: 11492364 Volare: 11492364 Caio: 0221.0104.001	Traseira	LED BIVOLT		4 vias selado

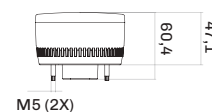
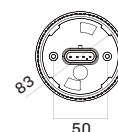

Euro 4 DRL (Daytime Running Light)



Código	Fixação	Tensão	Observação	Conexão
2770 19 30 4F			DRL + posição	4 vias selado
2770 16 30 4F	Traseira	LED BIVOLT	DRL + posição + direcional	4 vias selado

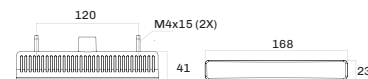

Lanterna direcional dianteira Ø75mm LED Marcopolo Ideale e Senior



Código	Cód. Original	Fixação	Tensão	Conexão
2093 24	Marcopolo: 10355998 Volare: 10355998 Caio: 2210095001	Traseira	LED 24V	2 vias selado
2093 12	-		LED 12V	

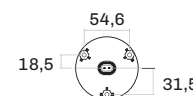
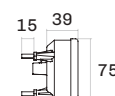



Lanterna direcional dianteira LED Marcopolo Torino



ECE



Código	Cód. Original	Fixação	Tensão	Conexão
2091 24	Marcopolo: 10309023	Frontal	LED 24V	2 vias Bulldog 
2091 12	-		LED 12V	

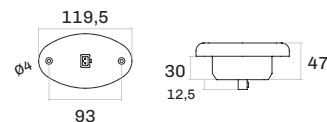

Lanterna direcional dianteira Marcopolo Torino e Volare



Código	Fixação	Cor	Observação	Conexão
1291 24	Frontal	Amarela	Sem lâmpadas	Soquete 091
1291 12		Cristal		



Lanterna direcional dianteira Marcopolo Senior e Ideale



Código	Fixação	Cor	Observação	Conexão
1293 CR	Traseira	Cristal	Sem lâmpadas	Soquete 093



Acessórios

qual tem produção
Sinalis





Suporte para placas de advertência



Código	Observação
3021 00 90 60	300x300mm
3025 00 90 60	400x300mm
3026 00 90 60	Fixador de suporte para placas de advertência



Acabamento traseiro central injetado

*Compatível com lanternas *S96* e *Vision*.



Código	Observação
3421 00 90 60	Espaço central para aplicação de logo

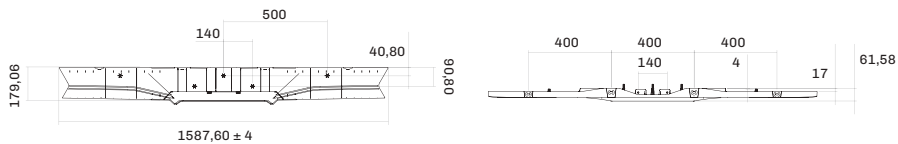

NOVO



Acabamento traseiro central injetado Infinite

*Compatível com lanternas *S96* e *Vision*.



Código	Observação
2830 11 30 20	Não possui iluminação Light Bar

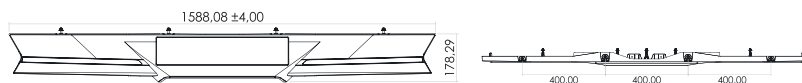



Três Marias

Conjunto traseiro LED anel de luz



Código	Fixação	Tensão	Cor	Observação	Conexão
2213 AM			Amarela	3 lanternas: 310mm	
2213 VM	Na base	LED BIVOLT	Vermelha		Fios
2215 VM				5 lanternas: 540mm	



Três Marias

Lanterna LED anel de luz



Código	Fixação	Tensão	Cor	Conexão
2210 AM			Amarela	Fios
2210 VM	Parafuso 3/8" x 11/4" na base	LED BIVOLT	Vermelha	

- ✓ Não enferruja: 100% plástico
- ✓ Resistência à água (IP67)
- ✓ Resistência a impacto

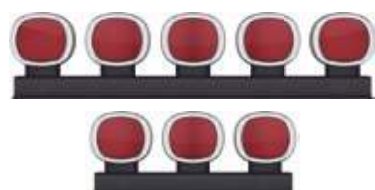
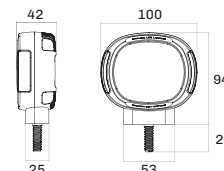

Três Marias

Conjunto traseiro LED iluminação clássica



Código	Fixação	Tensão	Cor	Observação	Conexão
2253 AM			Amarela	3 lanternas: 310mm	
2253 VM			Vermelha		
2255 AM	Na base	LED BIVOLT	Amarela	5 lanternas: 540mm	Fios
2255 VM			Vermelha		



Três Marias

Lanterna LED iluminação clássica



Código	Fixação	Tensão	Cor	Conexão
2250 AM	Parafuso 3/8" x 1 1/4" na base	LED BIVOLT	Amarela	Fios
2250 VM			Vermelha	

- ✓ Não enferruja: 100% plástico
- ✓ Resistência à água (IP67)
- ✓ Resistência a impacto

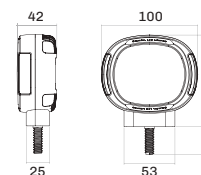

Lanterna Três Marias com lente removível



Código	Fixação	Cor	Conexão
1171 AM	Parafuso 3/8" x 1 1/4" na base	Amarela	Fios
1171 VM		Vermelha	

171 VM - Lente



Conjunto traseiro Três Marias com lente removível



Código	Fixação	Observação	Cor	Conexão
1173 VM	Na base	3 lanternas: 310mm	Vermelha	Fios

171 VM - Lente



Lanterna intermitente LED para elevadores de ônibus



Código	Fixação	Tensão	Conexão
2316	Traseira	LED BIVOLT	1 via FASTON 6,3mm



Luz de advertência LED do ABS



Código	Cód. Original	Fixação	Tensão	Conexão
2067 VD	WABCO: 4461055232	Frontal	LED BIVOLT	2 vias selado 

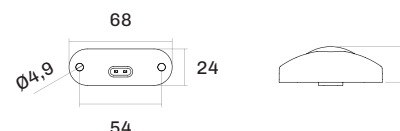

Luz direcional viraje amplo



Código	Fixação	Tensão	Conexão
2015 01 D 2015 01 E	Traseira	LED BIVOLT	Chicote 2 vias selado 

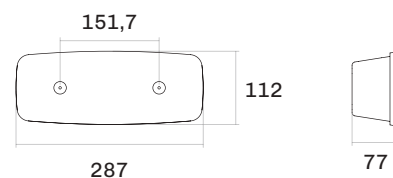



Iluminação de publicidade

Desenvolvida para diferentes tipos de veículos e necessidades de projeto, a Iluminação de Publicidade Sinansul adapta-se a múltiplas aplicações. Entre as mais comuns estão a iluminação de painéis publicitários nas laterais de ônibus e a iluminação da área de carga e descarga na traseira de baús de caminhão, valorizando também a comunicação visual impressa nas portas.



NOVO

Iluminação de publicidade com lanterna Intense



Disponível chicote 200



Código

Fixação

Tensão

Conexão

2850 11 30 60

Frontal

LED BIVOLT

2 vias selado

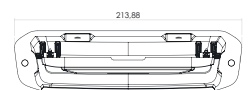
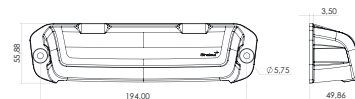

NOVO

Suporte para iluminação de publicidade



Código

Fixação

3460 00 90 60

Frontal

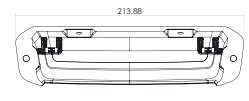
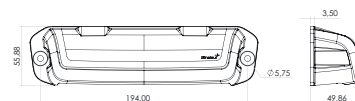



Lanternas de Placa





Suporte de placa universal com lanterna LED



Código	Fixação	Tensão	Conexão
3005	Superior	LED BIVOLT	2 vias selado
3007			Chicote 2 vias selado

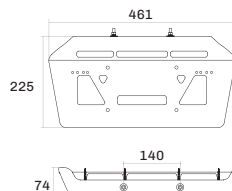

Lanterna de placa LED



Código	Cód. Original	Fixação	Tensão	Conexão
2105 CR	Busscar: 62.289101	Frontal	LED BIVOLT	2 vias selado
	Caio: 0221.0013.001			Chicote 2 vias selado
	Mascarello: 056681			Fios
2107 CR	-			
2106 CR	-			

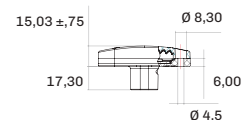
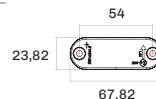

Lanterna de placa LED com bloqueador de luz



Código	Cód. Original	Fixação	Tensão	Conexão
2105 20 31 40	Caio: 0221.0097.001 Irizar: 8029265BR Marcopolo: 11601559 Volare: 11601559	Frontal	LED BIVOLT	2 vias selado

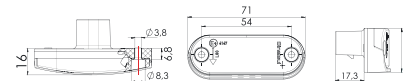



Lanterna de placa 90° LED



Disponível
chicote 200



Código	Cód. Original	Fixação	Tensão	Conexão
2600 20 30 40	Buscar: 62.509.614 Caio: 2.210.088.001	Frontal	LED BIVOLT	2 vias selado 

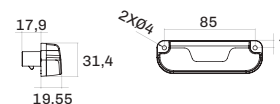

*Intercambiável com suportes de placa: Randon, Noma e Librelato



Lanterna de placa LED



Código	Fixação	Tensão	Conexão
2017	Frontal	LED BIVOLT	Fios



Lanterna de placa lâmpada torpedo



Código	Fixação	Observação	Conexão
1063 T	Frontal	Terminais para lâmpada torpedo	Fios



Lanterna de placa e iluminação de degrau Marcopolo



Código	Cód. Original	Fixação	Conexão
1010	Placa: 27201394 2 Degrau: 27201380	Frontal	Fios



Lanterna de placa



Código	Fixação	Observação	Conexão
1061	Traseira	Soquete para lâmpada 69	Fios



Retrorefletores

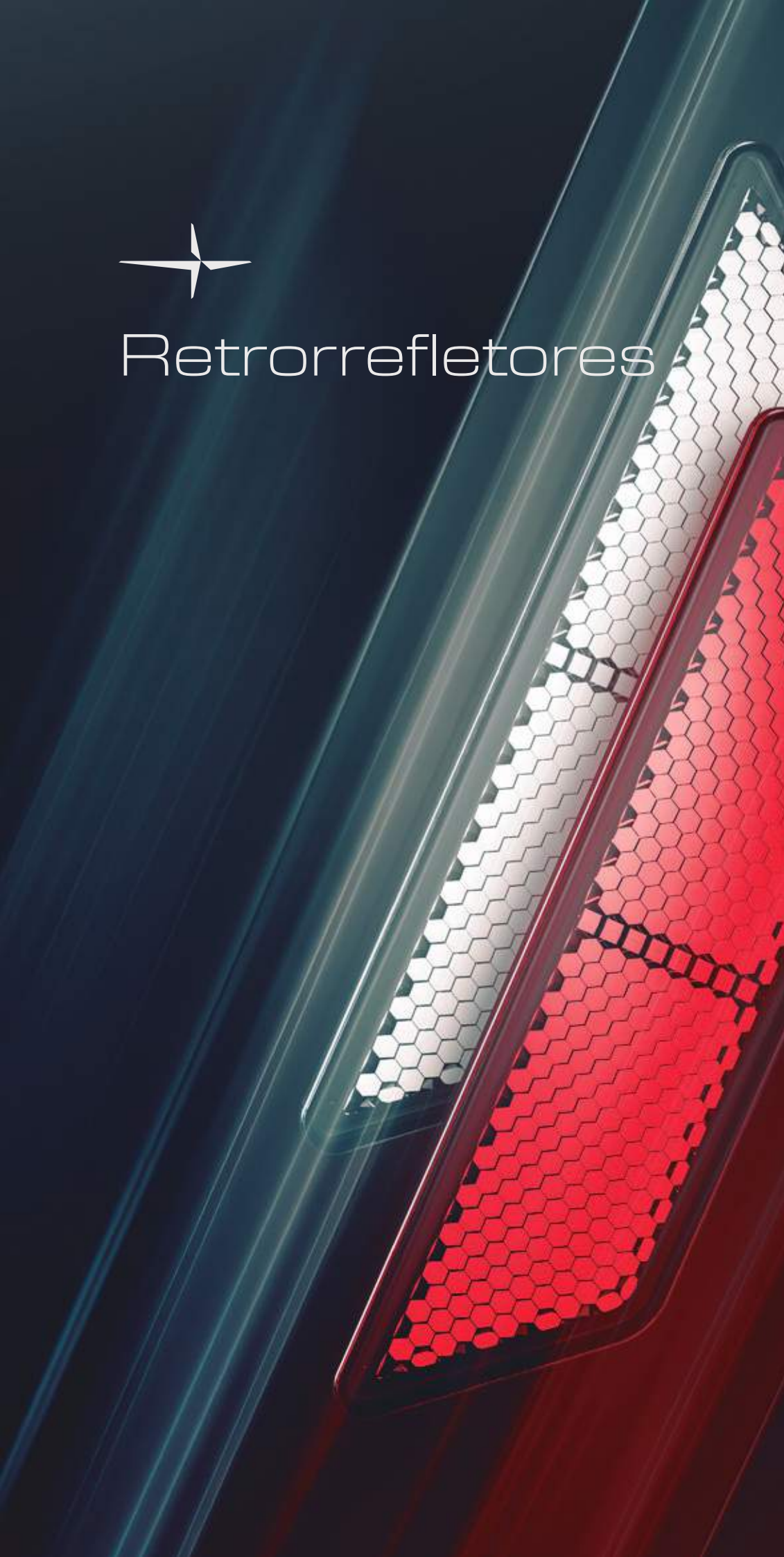



Retrorefletor Ø60mm



Código	Cód. Original	Fixação	Cor
1154 1 25 AM	Marcopolo: 3304500 1		Amarela
1154 1 25 VM	Marcopolo: 26200679 2	Parafuso M6 x 25mm	Vermelha
1154 1 25 CR	Marcopolo: 9920089 3		Cristal
1154 1 15 AM	-		Amarela
1154 1 15 VM	-	Parafuso M6 x 15mm	Vermelha
1154 1 15 CR	-		Cristal
1154 A AM	Caio: 0021.1266.002		Amarela
1154 A VM	Caio: 2.211.266.001	Adesivo	Vermelha
1154 A CR	-		Cristal

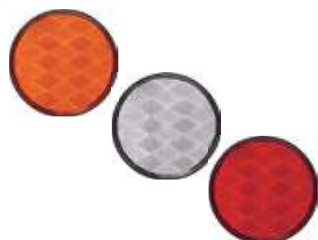
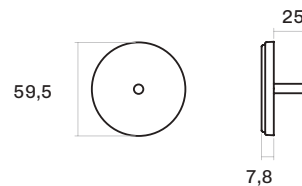

Retrorefletor Ø86mm



Código	Cód. Original	Fixação	Cor
1151 1 AM	-		Amarela
1151 1 VM	-	1 parafuso M5 x 30mm	Vermelha
1151 1 CR	-		Cristal
1151 2 AM	-		Amarela
1151 2 VM	-	2 parafuso M5 x 30mm	Vermelha
1151 2 CR	Marcopolo: 73161629		Cristal

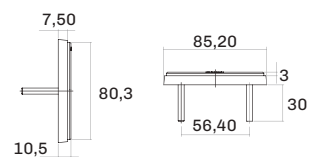



Retrorrefletor



Código	Fixação	Cor
1330 VM	2 parafuso M5 x 30mm	Vermelha
1330 CR		Cristal

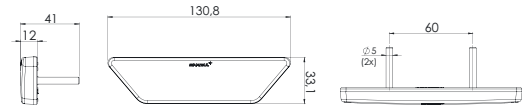

Triângulo retrorrefletor



Código	Cód. Original	Aplicações	Fixação
400 D	Rodofort: 4001195	2729, 2727, 2728, 2730	Traseira
400 E	Rodofort: 4001196		

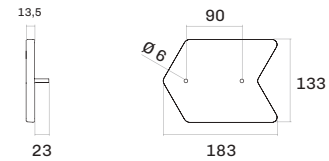

Triângulo retrorrefletor



Código	Aplicações	Fixação
300	1000, 2083, 2086, 2080, 2081, 2180	Traseira

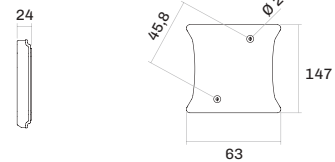



Triângulo retrorefletor

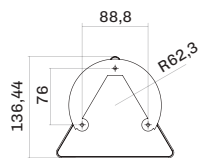

Código

Fixação

209

Traseira

299: Fixação

209, 299: Espessura

209: Fixação



Triângulo retrorefletor

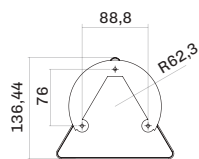

Código

Fixação

299

Traseira

299: Fixação

209, 299: Espessura

209: Fixação



Faróis de Trabalho





Elíptico

Farol de trabalho



Disponível chicote 200



Código	Fixação	Tensão	Observação	Conexão
2301	Com base de giro	LED 10-30V	Wide beam 40°	2 vias selado 
2302			Spot beam 20°	
23011	Sem base de giro	LED 10-30V	Wide beam 40°	2 vias selado 
23021			Spot beam 20°	

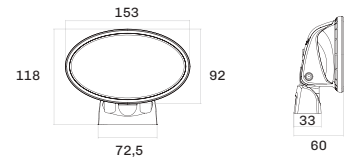

Base de giro

- ✓ Não enferruja: 100% plástico
- ✓ Resistente a impacto
- ✓ Selado: resistente à água (IP67)
- ✓ Encaixe para conexão selada embutida no farol



Powered by HELLA VALUEFIT

Farol de trabalho LED Hella Valuefit 700 lumens



Código	Fixação	Tensão	Observação	Conexão
2340	1 parafuso na base	LED 10-30V	Redondo	Fios

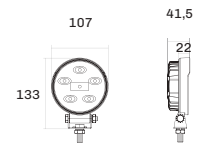

2340 - 5RD - Redondo

- ✓ Resistente a impacto
- ✓ Selado: resistente à água (IP67)
- ✓ Abertura de luz: curto alcance 60°

Powered by
**HELLA
VALUEFIT**

Farol de trabalho LED Hella Valuefit 700 lumens

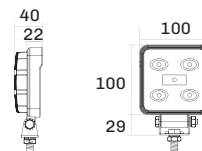
**2341 - 4SQ - Quadrado**

Código	Cód. Original	Fixação	Tensão	Observação	Conexão
2341	Irizar: 8027345BR	1 parafuso na base	LED 10-30V	Quadrado	Fios



- ✓ Resistente a impacto
- ✓ Selado: resistente à água (IP67)
- ✓ Abertura de luz: curto alcance 60°

Powered by
**HELLA
VALUEFIT**

Sinalizador de advertência LED Hella Giroflex FL Mini

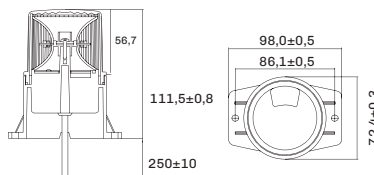

Código	Cód. Original	Fixação	Tensão	Conexão
2375 00 02 10	Irizar: 8028567BR	2 parafuso na base	LED BIVOLT	2 vias selado 
2375 00 01 10	-	2 parafuso na base	LED BIVOLT	Fios

- ✓ IP67 (resistente a imersão)
- ✓ IP X9K (resistente a limpadores de alta pressão)



Iluminação Interna





Dicróica

Lanternas para iluminação interna com acionamento touch



Código	Cód. Original	Fixação	Tensão	Temperatura de cor	Base	Conexão
2650 21 31 80	Marcopolo: 11770907			3500K	Cinza	
2650 21 31 60	Marcopolo: 11921265	Molas na base	LED BIVOLT		Preto	AMP 2 vias 
2651 21 32 40	-			5000K	Cinza	

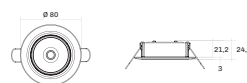
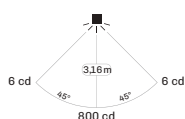

Dicróica

Lanternas para iluminação interna sem acionamento touch



Código	Cód. Original	Fixação	Tensão	Temperatura de cor	Base	Conexão
2650 21 30 80	Marcopolo: 11770822			3500K	Cinza	
2650 21 32 60	Marcopolo: 12724939	Molas na base	LED BIVOLT		Preto	AMP 2 vias 
2651 21 30 40	-			5000K	Cinza	

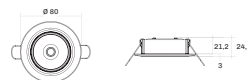
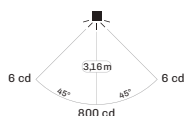

Plafon

Lanternas para iluminação interna



Código	Cód. Original	Fixação	Tensão	Temperatura de cor	Base	Conexão
2640 21 20 60	Marcopolo: 11677356 Comil: 196943			3500K	Preto	
2640 21 20 80	Busscar: 62.551.892	Molas na base	LED 24V		Cinza	AMP 2 vias 

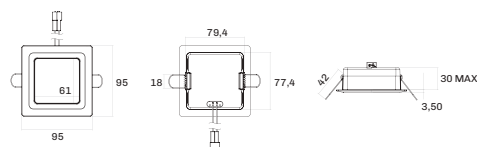
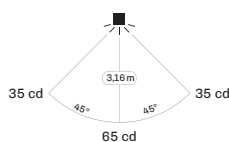



Lanterna para iluminação interna 6 LEDs



Código	Fixação	Tensão	Temp. de cor	Conexão
2266	Adesivo	LED BIVOLT	5000K	Fios

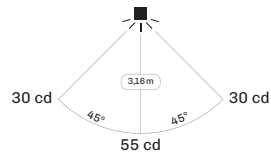
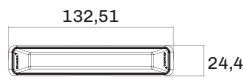
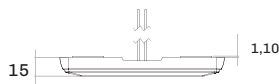

Intense

Lanterna para iluminação interna 6 LEDs



Código	Fixação	Tensão	Temp. de cor	Conexão
2265 21 30 60	Frontal	LED BIVOLT	5000K	Fios

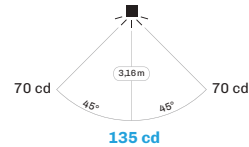
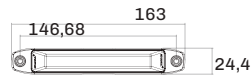
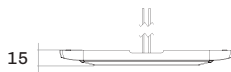

MAIOR INTENSIDADE DE ILUMINAÇÃO



Lanterna para iluminação interna 6 LEDs



Código	Fixação	Tensão	Temp. de cor	Conexão
2269 21 30 40	Frontal	LED BIVOLT	5000K	Fios

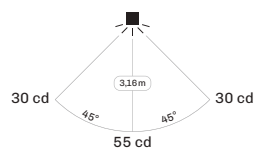
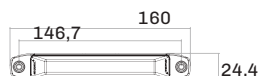
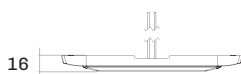

PROTEÇÃO ESPECIAL PARA BAÚS REFRIGERADOS



Lanterna para iluminação interna 6 LEDs



Código	Cód. Original	Fixação	Tensão	Temp. de cor	Conexão
2262	Marcopolo: 11004783 / 10986840	Frontal	LED BIVOLT	5000K	Fios
2262 11 31 40	-	Frontal	LED BIVOLT	5000K	Cabo PP chato 500mm

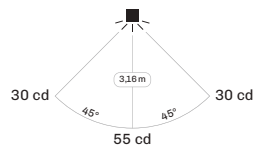
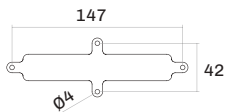

Lanterna para iluminação interna 4 LEDs com interruptor



Código	Fixação	Tensão	Base	Temp. de cor	Conexão
2261	Frontal	LED BIVOLT	Branca	5000K	Fios
2261 21 35 40			Preta		

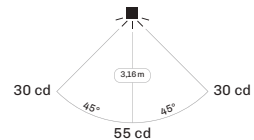
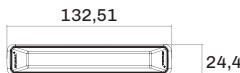
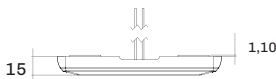

Lanterna para iluminação interna 13 LEDs



Código	Cód. Original	Fixação	Tensão	Conexão
2122 24	Caio: 0223.0029.002	Frontal	LED 24V	Fios
2122 12	Caio: 0223.0029.001	Frontal	LED 12V	

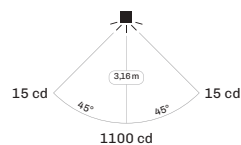
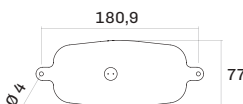



Light Bar

Lanterna para iluminação interna



Código	Fixação	Tensão	Tem. de cor	Conexão
2810 11 30 40	Frontal	LED BIVOLT	5000K	Cabo PP 2 vias 400mm

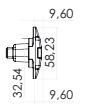
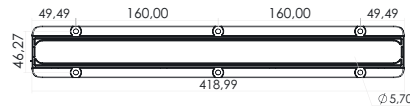



Sistemas eléctricos





Módulo direcional categoria 5



Código

Tensão

Conexão

0120 00 30 60

LED BIVOLT

Cabo PP 2 vias retangular

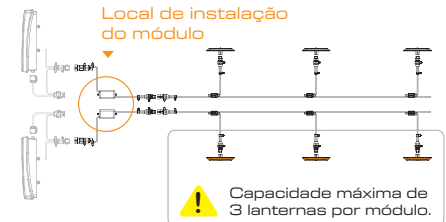

Solução para atendimento da norma CATEGORIA 5 em veículos sobre chassi de até 9 metros

O módulo fará a mesma função da caixa de distribuição com as lanternas: 2661 e 2665 (p.60 e 61)

5000 00 30 60



Saída para auxiliar de posição

Módulo eletrônico para controle de LED em implementos



Utilização apenas em corrente contínua

5000 00 30 60

Código

Tensão

Conexão

5000 00 30 60

Cabo PP 2 vias retangular

LED BIVOLT

5000 00 33 60

7 vias SINALSUL e auxiliar de posição cabo PP 2V retangular



1014 Click
(derivador rápido)



Conexão dos conjuntos traseiros através do conector ou 5 vias selado Tyco



Conexão das lanternas de posição através de conector Tyco 2 vias selado



Sirene de ré



Este produto deve, obrigatoriamente, ser instalado virado para baixo.

Código

Fixação

Tensão

Pressão sonora

Conexão

5100 26 30 60

Frontal

LED BIVOLT

90db

Fios

5100 26 31 60

Cabo PP 2m com conector 2 vias selado

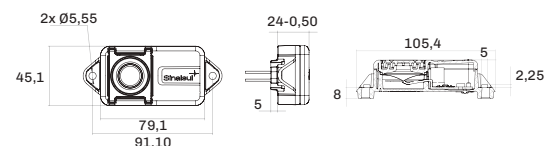



5020 00 30 60

O módulo eletrônico sincroniza o direcional traseiro com todas as lanternas laterais amarelas do implemento. Ao acionar o pisca, todo o conjunto pisca junto. O módulo de carga integrado simula o consumo de lâmpadas convencionais, garantindo a diagnose correta pelo sistema do caminhão.

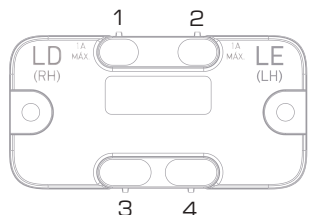

Item	Função
1	Saída lateral direita (2 vias)
2	Saída lateral esquerda (2 vias)
3	Conexão de entrada direita (3 vias)
4	Conexão de entrada esquerda (3 vias)

5090 00 30 60

Em conformidade com a norma **CONTRAN 761**, o módulo eletrônico atua em conjunto com as lanternas laterais **2661 e 2665** — que reúnem luz de posição e LED direcional em um único produto. Ao acionar o pisca, todas as lanternas laterais do implemento piscam junto com a traseira, de forma sincronizada. O módulo de carga integrado simula o consumo de lâmpadas convencionais, assegurando a diagnose correta pelo sistema do caminhão.

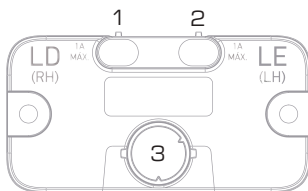

Item	Função
1	Flashing lateral direita (2 vias)
2	Flashing lateral esquerda (2 vias)
3	Conexão de entrada (7 vias)

Instalação:

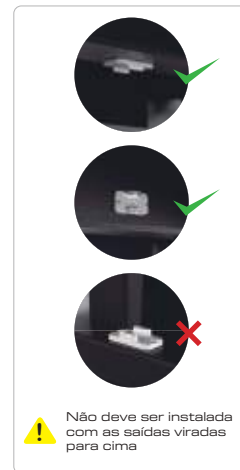

NOVO

Módulo eletrônico flashing 7 vias com módulo de carga

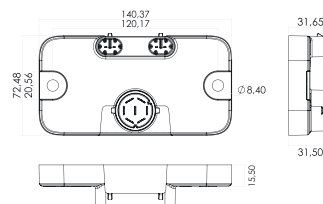

Código	Tensão	Conexão
5020 00 30 60	LED BIVOLT	Saída conector 7 vias Sinalsul + 2 vias selado



NOVO

Módulo eletrônico flashing CAT5 com módulo de carga

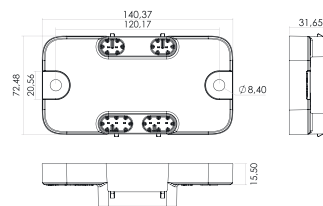

Código	Tensão	Conexão
5090 00 30 60	LED BIVOLT	3 vias selado + 2 vias selado

FORVIA
HELLA

Leveller Hella para farol

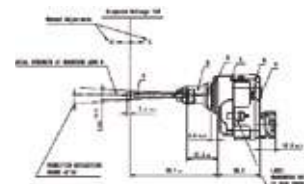

Código	Tensão	Observação	Conexão
5700 00 20 60	LED BIVOLT	Aplicação: Farol Mercedes-Benz Accelo ≤ 2025	3 vias Baioneta



012 Soquete com haste 1 polo



014 Rabicho 1 polo com fio 160mm



017 Soquete com luva, fios 100mm, terminais macho 2,8 X 0,8 e dois conectores 1 via FASTON para as lanternas 1188, 1288 e 1289 padrão Marcopolo



023 Soquete para a lanterna 1069



024 Soquete para a lanterna 1124



025 Soquete nylon 1 polo com haste e fio 160mm



026 Soquete nylon 2 polos com haste e fio 150mm



027 Soquete universal nylon 1 polo



028 Soquete universal nylon 2 polos



032 Porca plástica M5 AFF para fixação das lanternas Mercedes-Benz, faróis e outros



034 Coxim para lanternas traseiras



035 Chicote 220mm para função 1 polo



036 Soquete com luva, fios 190mm e dois conectores 1 via FASTON para as lanternas 1178 e 1199



037 Chicote com luva e soquete 1 polo



039 Chicote 220mm para função 2 polos



051 Soquete com luva, fios 190mm, terminal macho e conector 2 vias FASTON para as lanternas 1186



080 Chicote 190mm com conector selado 5 vias Tyco para a lanterna 1080



091 Soquete 1 polo para as lanternas 1291, 1292

092 Soquete 2 polos para a lanterna 1292



093 Soquete 1 polo para lâmpada PY com saída para conector selado 2 vias AMP



094 Soquete 1 polo para a posição da lanterna 1310



095 Soquete 1 polo para o direcional da lanterna 1310



200 Chicote 150mm com conector selado 2 vias



201 Chicote 150mm com conector selado 2 vias e 2 vias FASTON



206 Chicote 150mm com conector selado 4 vias Tyco



208 Chicote 200mm 7 vias Tyco para as lanternas 1025, 1347, 1348, 1345, 1346, 1090 e 1091



211 Chicote 150mm com conector selado 2 vias Junior Power Timer 2,8mm



215 Chicote 500mm cabo PP com conector selado 5 vias Tyco



303 Chicote 150mm com conector selado 3 vias Tyco



305 Chicote 150mm com conector selado 5 vias Tyco



0420 00 92 60

Chicote com conector 7 vias para lanterna 1420



0430 00 90 60

Chicote adaptador HDSC 2 vias



0440 00 90 60

Chicote adaptador HDSC 3 vias



Código	Metragem
9002	300mm
9410	1000mm
9034	1500mm
9076	2000mm
9094	2000mm

9002 300mm

9410 1000mm

9034 1500mm

9076 2000mm

9094 2000mm

Cabo chato PP 2 vias com conector 2 vias Tyco



30
ANOS

30 anos construindo soluções com tecnologia e responsabilidade para quem vive a estrada todos os dias.



Índice





MERCEDES-BENZ

ATEGO



ATEGO 2012 EM DIANTE



AXOR



ATRON





MERCEDES-BENZ

ATRON



ACTROS



NOVO ACCELO



ACCELO





MERCEDES-BENZ

1620



1938S | 1944S



712 | 719 | 911

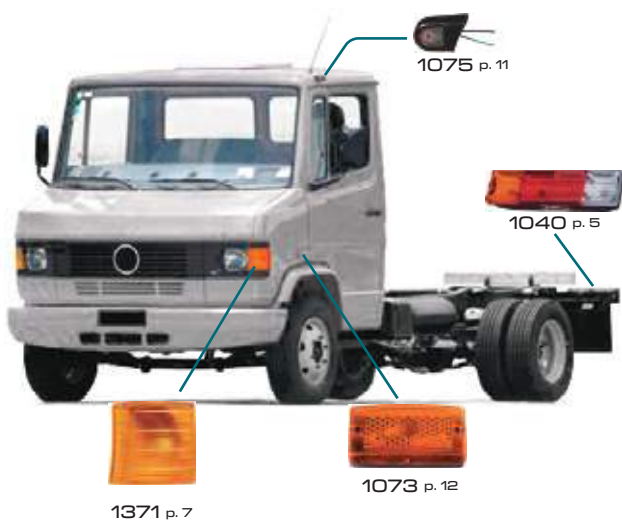

1518 | 1313 | 1113





SCANIA

SÉRIE 5



SÉRIE 5



SÉRIE 4



SÉRIE 113

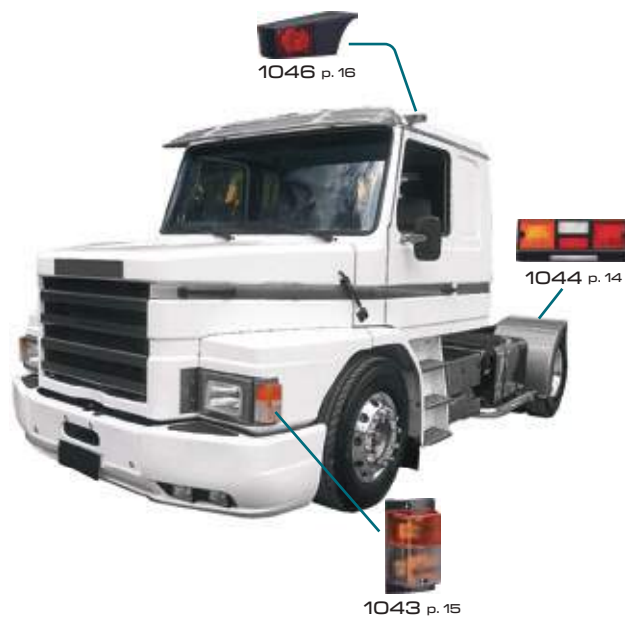



VOLVO

FH



VM



FH

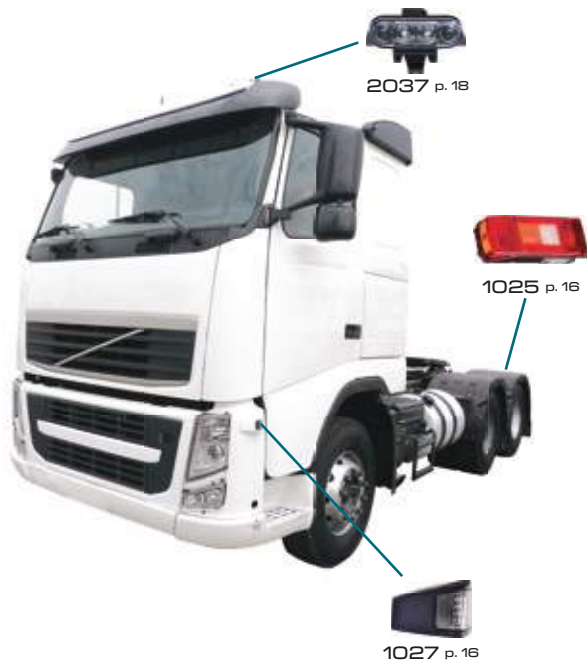

FH





FORD

CARGO



CARGO



CARGO





VOLKSWAGEN

WORKER



DELIVERY



DELIVERY



CONSTELLATION





IVECO

TECTOR



MAN

MAN





Lanternas traseiras



2840 p. 31



2727/28/29 p. 41



2083, 2086 p. 42



2780 p. 32



2810 p. 33



2360/62 p. 39



2761/63 p. 37



2780 p. 32

Acabamentos Centrais



3421 p. 88



2830 p. 33



Laterais & Delimitadoras



2660 p. 61



2160 p. 69



2057 p. 67



2059 p. 68



2610 p. 60



2055 p. 66



2056 2 p. 63



2042 p. 64



2046 p. 69



2486 p. 81



2480 p. 81

Luz de placa



3005 p. 94



2600 p. 95



2105 p. 94



2017 p. 95

Sistemas elétricos



5020 p. 112



5090 p. 112



5000 p. 111



1014 p. 111



0120 p. 111



5100 p. 111



Acessórios & Internas



2316 p. 91 2261 p. 108 2650 p. 105 2640 p. 105 2850 p. 92

Dianteiras:

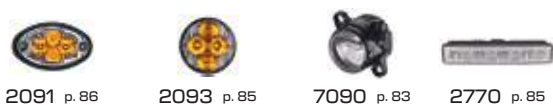

2091 p. 86 2093 p. 85 7090 p. 83 2770 p. 85



2490 p. 85 1293 p. 86 7091, 7092 p. 86

Delimitadoras & Traseiras



2064 p. 71 2078 p. 78 2440 p. 78 1178 p. 79

1176 p. 80 1289 p. 79 1288 p. 80 1188 p. 80

2821 p. 48 2095 p. 48



Laterais



2056 p. 63 2680 p. 61 2664 p. 61 2040 p. 64

2036 p. 62 2670 p. 62 1199 p. 79 1186 p. 77

Luz de placa



2105 p. 94 2600 p. 95

2105 p. 94 1010 p. 96

Traseiras



2071 p. 50 1207 p. 50 2190 p. 54 2491, 2492 p. 48 - 49 1154 p. 98

2540, 2530 p. 35 - 36 2535 p. 35 2740 p. 34, 35 2750 p. 36, 37 1330 p. 99



012	113	248	19	1120	76	1370	23	2067	91	2280	65	2750	37,36
0120	111	250	16	1124	78	1371	7	2069	13,26	2290	54	2761	37
014	113	276	26	1129	46	1372	7	2070	50	2291	54	2763	37
017	113	277	24	1130	46	1389	56	2071	50	2292	54	2770	85
023	113	299	100	1137	27	1390	56	2072	53	2301	102	2780	32
024	113	300	99	1138	77	1391	51	2074	53	2302	102	2810	33,109
025	113	301	26	1139	75	1392	51	2078	78	2316	91	2821	48
026	113	303	114	1141	52	1410	9	2080	42	2340	102	2830	33,88
027	113	305	114	1143	51	1420	5	2081	42	2341	103	2840	31
028	113	345	14	1145	70	1440	28	2083	42	2350	38	2850	92
031	20	346	14	1147	56	1450	29	2086	42	2351	38	2999	9
032	113	347	5	1151	98	1513	6	2087	43	2352	38	3005	94
034	113	348	5	1154	13,98	1514	6	2091	86	2360	39	3007	94
035	113	400	99	1155	57	2006	55,56	2093	85	2361	39	3021	88
036	113	513	6	1156	57	2007	55	2095	48	2362	39	3025	88
037	113	514	6	1157	56	2008	49	2096	48	2363	39	3026	88
038	113	707	45	1159	70	2009	49	2105	94	2375	103	3201	38
039	113	1000	42	1160	73	2011	67	2106	94	2400	106	3360	40
040	5	1010	96	1164	65	2012	73	2107	94	2440	78	3361	40
0420	114	1014	111	1165	73	2014	12	2111	72	2480	81	3421	88
043	15	1023	17	1166	22	2015	91	2120	47	2486	81	3430	5
0430	114	1024	17	1169	22	2016	75	2121	47	2490	85	3440	28
044	14	1025	16	1170	22	2017	95	2122	108	2491	49	3450	29
0440	114	1026	16	1171	90	2023	55	2125	20	2492	48	3460	92
051	113	1027	16	1173	90	2024	55	2126	21	2530	35	5000	111
058	9	1032	20	1176	80	2026	18	2130	47	2531	35	5020	112
065	10	1033	20	1178	79	2027	7	2131	44	2532	35	5090	112
066	10	1040	5,19	1180	52	2028	7	2132	45	2534	28	5100	111
068	11	1041	19	1181	52	2029	67	2133	47	2535	35	5700	113
073	12	1043	15	1186	77	2030	68	2160	69	2540	36	7000	45
077	6,7	1044	14	1188	80	2031	44	2171	49	2541	36	7001	45
080	113	1046	16	1195	23,77	2032	44	2180	43	2542	36	7007	46
087	20	1049	14	1199	79	2033	73	2190	54	2544	28	7017	46
091	114	1052	8	1200	57	2034	71	2191	54	2545	35	7090	83
092	114	1057	11	1201	58	2036	62	2192	54	2570	17	7091	84
093	114	1058	9	1202	57	2037	18	2202	45	2580	27	7092	84
094	114	1061	96	1204	52	2038	43	2210	89	2590	21	9002	114
095	114	1063	95	1207	50	2039	75	2213	89	2600	95	9410	114
116	81	1065	10	1247	19	2040	64	2215	89	2610	60	9034	114
117	74	1066	10	1248	19	2041	64	2220	69	2620	15	9076	114
118	46,76	1068	11	1269	24	2042	64	2221	69	2630	15	9094	114
122	75	1069	12,26	1270	24	2043	64	2222	69	2640	105		
138	77	1073	12	1276	25	2044	68	2235	40	2641	106		
145	70	1075	11	1277	25	2045	68	2236	40	2650	105		
163	73	1077	6	1288	80	2046	69	2237	40	2651	105		
169	22	1078	8	1289	79	2047	69	2238	40	2660	61		
171	90	1080	5,19	1291	86	2048	66	2242	27	2661	60		
176	80	1086	20	1292	53	2049	66	2250	90	2664	61		
200	114	1087	20	1293	86	2052	66	2253	89	2665	61		
201	114	1090	5	1310	21	2055	66	2255	89	2670	62		
206	114	1091	5	1315	23	2056	63	2261	108	2680	61		
208	114	1104	46	1330	99	2057	67	2262	108	2726	41		
209	100	1106	10	1345	14	2059	68	2264	71	2727	41		
211	114	1116	81	1346	14	2062	25	2265	106,107	2728	41		
215	114	1117	74	1347	5	2063	25	2266	107	2729	41		
242	27	1118	76	1348	5	2064	71	2267	72	2730	41		
247	19	1119	76	1360	8	2066	71	2269	107	2740	34,35		

